

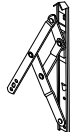

Architectural Windows

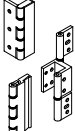
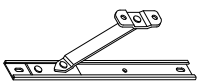
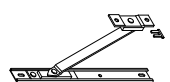

Projected and Casement

COMPONENT	MATERIAL	FINISH	WINDOW SERIES													FEATURES				
			2-3-4250i INvent™	All -XLT INvent™	2250 Insert Vents	2-3-4250 Series	2250-E Epic™	2-3-4250-LP	2250i-BHM Blast	3250-H Heritage™	3-4250i-V Visulime™	3250-HP Hurricane	3250i-HP Hurricane	4000i-DT Psych	3250-Z ZSL		4250-OS Offset	4250-Z Multi-lock	TD-4250i Terrace	2200 (Web only)
HINGES																				
Four-Bar Hinges 10" 16" 24" 	Stainless Steel	Uncoated	●	●	●	●	●	●	●	○	●	●	●	●	●	●	Our most popular hinge selection. High performance concealed hinges with friction adjustment. Recommended casement vent weight limit is 115 lbs. Projected weight limits vary, please consult with Wausau on projected vents over 15 sq ft.			
Butt Hinges Half-Mortise Concealed Surface Mounted 	Aluminum	Exposed Surfaces Match Window	○	○	○	○	○	○	○	○	○	○	○	○	○	○	●	High strength extruded aluminum hinges with coated stainless steel pins, nylon separators and end caps. Recommended for egress or large vent size. Always used in conjunction with friction adjusters.		
VENT CONTROL DEVICES																				
Friction Adjuster 	Stainless Steel	Uncoated	○	○	○	○	○	○	○	○	○	○	○	○	○	○	○	○	Limits casement swing to 85°. Adjusting set screw applies friction for smooth operation. Always use with butt hinges. <small>* Terrace doors are fitted with LCN 4040 closers.</small>	
Limited Opening Device 			○	○	○	○	○	○	○	○	○	○	○	○	○	○	○	○	○	Limits opening for low sills, child safety, buffeting wind, limited projection or emergency ventilation. Keyed release to extend opening. <small>* Terrace doors are fitted with LCN 4040 closers.</small>
Keyed Support Arm 			○	○	○	○	○	○	○	○	○	○	○	○	○	○	○	○	○	Used on top-hinged-inswing vents if height exceeds 25" or if weight is a concern. First setting locks at 1 1/2" extension; key release for extended opening. Consult Wausau for recommended usage on awnings.
Limited Opening Stop Block 	Aluminum	Mill	○	○	○	○	○	○	○	○	○	○	○	○	○	○	○	Installed in track of four-bar hinge to limit opening, as an alternate to a separate limited opening devices.		

DISCLAIMER: Wausau Window and Wall Systems takes no responsibility for product selection or application, including, but not limited to, compliance with building codes, safety codes, laws, merchantability or fitness for a particular purpose; and further disclaims all liability for the use, in whole or in part, of this Hardware Selection Guide in preparation of project specifications and/or other documents. Hardware Selection Guides are subject to change at any time, without notice, and at Wausau's sole discretion. ©2010 Wausau

Architectural Windows

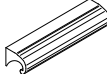
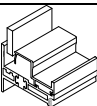

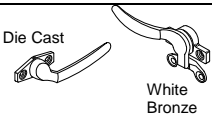
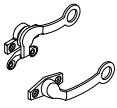
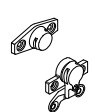
Projected and Casement (continued)

COMPONENT	MATERIAL	FINISH	WINDOW SERIES													FEATURES				
			2-3-4250i INvent™	All -XLT INvent™	2250 Insert Vents	2-3-4250 Series	2250-E Epic™	2-3-4250-LP	2250i-BHM Blast	3250-H Heritage™	3-4250i-V Visulime™	3250-HP Hurricane	3250i-HP Hurricane	4000i-DT Psych	3250-Z ZSL		4250-OS Offset	4250-Z Multi-lock	TD-4250i Terrace	2200 (Web only)
PULL HANDLES																				
Waterfall Pull 	Aluminum	To Match Window	○	○	○	○	○												○	Applied to hand-operated project-out casement and awning vents when keeper locks are employed.
Pull Bead 	Aluminum	To Match Window	○	○	○	○		○											○	Pull handle extruded into profile of glazing beads.
Pole Ring 	White Bronze	Clear E-Coat	○	○	○	○	○	○		○									○	Used when vents are out of reach. Most common on hopper vents. Available for awnings. Extruded aluminum pole operator and eye hook provided.
LOCKS																				
Cam Handles LH or RH Project-in or Project-out 	Zinc Die Cast	Brushed Copper Nickel, Standard Painted Colors	●	●	●	●	●	●	●	○	●	○							●	Die cast handles are a contemporary economical alternative to the rich, smooth, retro appearance of white bronze.
Ring Cams 	or	or	○	○	○	○	○	○	○	○	○								○	Used when vents are out of reach. Most common on hopper vents. Available for awnings. Extruded aluminum pole operator and eye hook provided.
Handle-less Cam with Removable Key 	White Bronze	Clear E-Coat	○	○	○	○	○	○	○	○									○	Used for custodial operation of casements, hoppers and awnings.

DISCLAIMER: Wausau Window and Wall Systems takes no responsibility for product selection or application, including, but not limited to, compliance with building codes, safety codes, laws, merchantability or fitness for a particular purpose; and further disclaims all liability for the use, in whole or in part, of this Hardware Selection Guide in preparation of project specifications and/or other documents. Hardware Selection Guides are subject to change at any time, without notice, and at Wausau's sole discretion. ©2010 Wausau

Architectural Windows

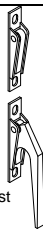

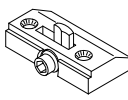
Projected and Casement (continued)

COMPONENT	MATERIAL	FINISH	WINDOW SERIES												FEATURES				
			2-3-4250i INvent™	All -XLT INvent™	2250 Insert Vents	2-3-4250 Series	2250-E Epic™	2-3-4250-LP	2250i-BHM Blast	3250-H Heritage™	3-4250i-V Visulime™	3250-HP Hurricane	3250i-HP Hurricane	4000i-DT Psych		3250-Z ZSL	4250-OS Offset	4250-Z Multi-lock	TD-4250i Terrace
LOCKS (continued)																			
Single Point Keeper 	Zinc Die Cast	Brushed Copper Nickel, Standard Painted Colors	○	○	○	○		○		○	○				○	○		○	Keepers can help avoid the need for wicket screens. Die cast handles are a contemporary and economical alternative to the rich, smooth, retro appearance of white bronze.
	White Bronze	Clear E-Coat	●	●	●	●	●	●	●	○					○	●		●	Keepers are most commonly frame-mounted on project-out casements and awnings. Can also be vent-mounted on inswing casements and hoppers. White bronze is Wausau's standard hardware finish.
Two Point Keeper (Three Point Keeper also available)  	Zinc Die Cast	Brushed Copper Nickel, Standard Painted Colors	○	○	○	○		○		○	○				○	○		○	Die cast handles are a economical alternative to the rich, smooth appearance of white bronze.
	White Bronze	Clear E-Coat	●	●	●	●	●	●	●	○					●	○	●	●	Two- and three-point keepers allow single handle operation of taller vents, while avoiding the need for wicket screens.
Concealed Lock 	Zinc Die Cast Lock with Nylon Housing	Uncoated	○	○	○	○		○		○					○	○		○	Concealed flush-mount hex-keyed lock for custodial operation.
Tamper Resistant Concealed Lock			○	○	○	○		○		○						●	○	○	○

DISCLAIMER: Wausau Window and Wall Systems takes no responsibility for product selection or application, including, but not limited to, compliance with building codes, safety codes, laws, merchantability or fitness for a particular purpose; and further disclaims all liability for the use, in whole or in part, of this Hardware Selection Guide in preparation of project specifications and/or other documents. Hardware Selection Guides are subject to change at any time, without notice, and at Wausau's sole discretion. ©2010 Wausau

Architectural Windows

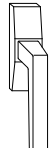
Projected and Casement (continued)

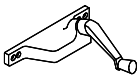
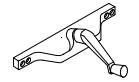
COMPONENT	MATERIAL	FINISH	WINDOW SERIES													FEATURES				
			2-3-4250i INvent™	All -XLT INvent™	2250 Insert Vents	2-3-4250 Series	2250-E Epic™	2-3-4250-LP	2250i-BHM Blast	3250-H Heritage™	3-4250i-V Visulime™	3250-HP Hurricane	3250i-HP Hurricane	4000i-DT Psych	3250-Z ZSL		4250-OS Offset	4250-Z Multi-lock	TD-4250i Terrace	2200 (Web only)
LOCKS (continued)																				
Security Lock 	Zinc Die Cast	Brushed Copper Nickel, Standard Painted Colors															●		Used for additional security on inswing casement and hopper windows. Key is non-removable in the unlocked position.	
Multi-Lock Set 	Aluminum	Clear or Bronze Anodized, Standard Painted Colors										●	●					●	A popular modern option for selected project-in and project-out casements, awnings and hoppers. Single-handle operation, with concealed locking points and optional corner drive units for large vents. Removable handle available.	
Terrace Door Lock Set 																			●	Verona-style terrace door handle with manual compression lock feature. Interior and exterior operation. <small>* Terrace doors are fitted with LCN 4040 closers.</small>
Terrace Door Thumb Turn 																			○	Supplemental interior lock for added security on terrace doors.
OPERATORS																				
Roto Operator (Single Arm) 	Zinc Die Cast	Brushed Copper Nickel, Standard Painted Colors	●	●	●	●	●	2250 only	●	●			●		●	●		●	Single arm rotos used with outswing casement vents can avoid the need for wicket screens. Always use friction adjusters if rotos are used in conjunction with butt hinges.	
Roto Operator (Dual Arm) 			●	●	●	●	●	2250 only	●	●			●		●	●			●	Dual arm rotos used with awning vents can avoid the need for wicket screens. Always use friction adjusters if rotos are used in conjunction with butt hinges.

DISCLAIMER: Wausau Window and Wall Systems takes no responsibility for product selection or application, including, but not limited to, compliance with building codes, safety codes, laws, merchantability or fitness for a particular purpose; and further disclaims all liability for the use, in whole or in part, of this Hardware Selection Guide in preparation of project specifications and/or other documents. Hardware Selection Guides are subject to change at any time, without notice, and at Wausau's sole discretion. ©2010 Wausau

Architectural Windows

Projected and Casement (continued)

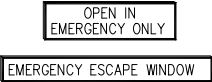
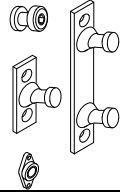
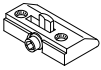
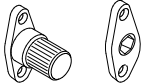
COMPONENT	MATERIAL	FINISH	WINDOW SERIES													FEATURES			
			2-3-4250i INvent™	All -XLT INvent™	2250 Insert Vents	2-3-4250 Series	2250-E Epic™	2-3-4250-LP	2250i-BHM Blast	3250-H Heritage™	3-4250i-V Visulime™	3250-HP Hurricane	3250i-HP Hurricane	4000i-DT Psych	3250-Z ZSL		4250-OS Offset	4250-Z Multi-lock	TD-4250i Terrace
SPECIALTY																			
Egress Tags 	Aluminum	Painted (Red on White)	○	○	○	○	○	○	○	○	○	○	○	○	○	○	○	○	Applied to egress windows as required. Check local codes for specific requirements.
Window Washing Restraint and Tieback 	Cast Stainless Steel	Brushed or Painted to Match Window	○	○	○	○	○	○	○	○	○	○	○	○	○	○	○	○	Standard stabilizer, single post, double post or flush-mounted spring loaded. Check local codes for specific requirements, and consult with a window washing equipment specialist.
INTEGRAL BETWEEN-GLASS VENETIAN BLIND CONTROLS																			
Access Door Lock 	Zinc Die Cast in Nylon Housing	Uncoated	○	○	○	○													Provides custodial access to concealed raise-lower cords, and for periodic cleaning. Access doors are also equipped with pin hinges as a standard, lift-out optional.
Venetian Blind Tilt Control 	Nylon	Black	○	○	○	○													Occupant tilt, concealed custodial raise-lower. Available keyed, or with removable control knob.
<p>GENERAL NOTE: Hardware Selection Guides are intended to provide an overview of Wausau's most popular hardware options. Vent size and desired functionality can play major roles in determining appropriate hardware selection, as can local code requirements. Certain hardware types can affect the Wausau Standard Limited Warranty. Please contact Wausau for more options and detailed information.</p>																			

DISCLAIMER: Wausau Window and Wall Systems takes no responsibility for product selection or application, including, but not limited to, compliance with building codes, safety codes, laws, merchantability or fitness for a particular purpose; and further disclaims all liability for the use, in whole or in part, of this Hardware Selection Guide in preparation of project specifications and/or other documents. Hardware Selection Guides are subject to change at any time, without notice, and at Wausau's sole discretion. ©2010 Wausau

Architectural Windows

Projected and Casement (continued)

MINIMUM VENT DIMENSIONS

SIZE FACTOR TABLE

COMPONENT	MINIMUM SIZE FACTOR	NOTES
10" Four-Bar Hinge	11"	
Keeper (Single Point)	8"	
Keeper (Two Point)	Inquire	
Butt Hinge	14"	
Cam Lock	8"	
Limit Stop	Inquire	Dimension Varies with Degree of Opening
Support Arm	12"	Dimension Varies with Degree of Opening
Friction Adjuster	20"	
Dual Arm Roto	30"	For 10" Clear Opening
Roto/Single Arm	15"	Increases to 22" when used with Four-Bar Hinge

DIAGRAM

THE FOLLOWING IS AN EXAMPLE OF THE LIMITATIONS PRESENTED WITH A PARTICULAR HARDWARE CONFIGURATION. NOTE THAT THE SUM OF THE HARDWARE "SIZE FACTORS" DETERMINE THE MINIMUM SASH DIMENSION.

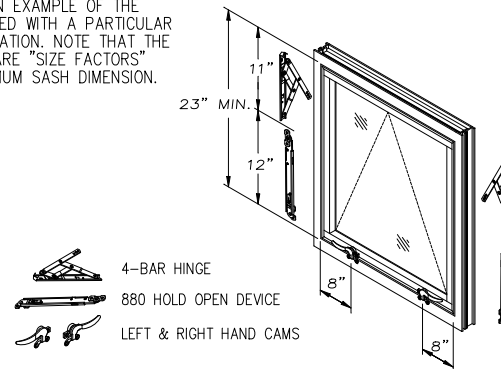

PHOTOGRAPH

