

in.vent[™]
...the future of windows...

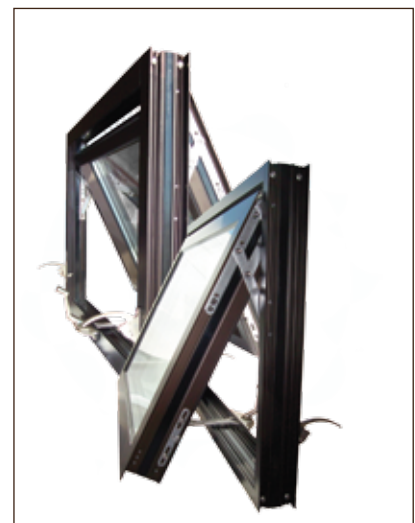

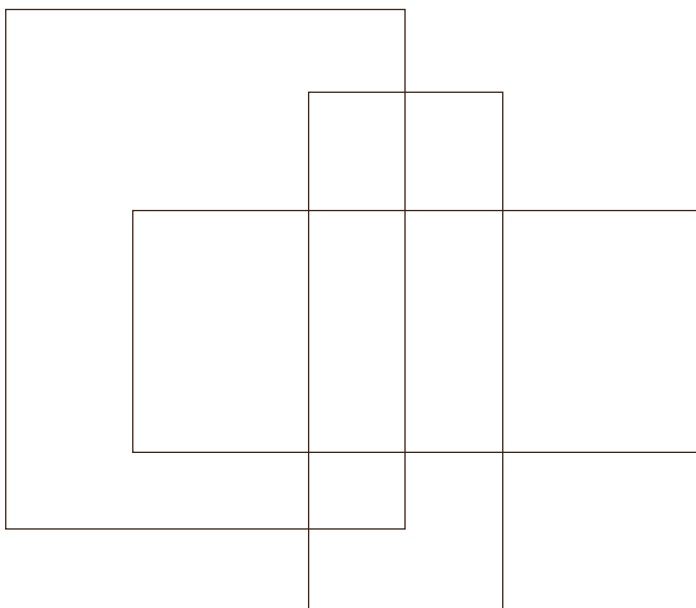

...the future of windows...

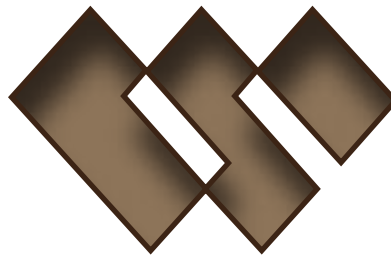

2250i . 3250i . 4250i 4250i-OS OFFSET INVENT

WAUSAU'S STANDARD HIGH-PERFORMANCE
PROJECTED WINDOW PRODUCT LINE

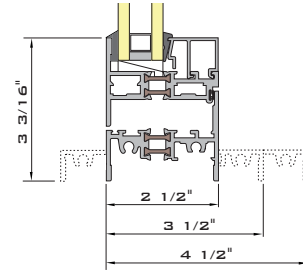

- 2-1/2", 3-1/2" and 4-1/2" frame depth with polyamide thermal barrier
- AAMA AW-100 Architectural Performance Class
- Fixed, project-in hopper, project-out awning, or casement
- Integral blinds with access doors available
- 1/8" wall thickness at hardware attachments
- Multi-lock hardware option for improved accessibility
- High recycled aluminum content, choice of 30,000 finish colors, including two-color option

Test results may vary

Allowable Air	Water	NFRC U-Factor	CRF _f	STC OITC
0.10 cfm/sqft at 6.24 psf	15 psf	0.34 to 0.64 BTU/hr.sqft.*F	46 to 65	31 to 42 26 to 37

Production line sampling, with inspection and **water testing prior to shipment**, helps ensure real-world performance equal to the laboratory.

INVENT -XLT

SUPERIOR ENERGY EFFICIENCY AND
CONDENSATION RESISTANCE

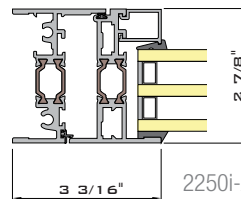

2250i-XLT



- 2-7/8", 3-7/8" and 4-7/8" frame depth
- XLT option features extra-wide polyamide thermal barrier
- AW-100 rating - Accepts triple glazing
- Glazed-in muntin grid option for historical renovation

Test results may vary

Allowable Air	Water	NFRC U-Factor	CRF _f	STC OITC
0.10 cfm/sqft at 6.24 psf	15 psf	0.21 to 0.60 BTU/hr.sqft.*F	59 to 68	31 to 42 26 to 37

2250i-XP INVENT.PLUS

EUROPEAN BENCHMARK THERMAL PERFORMANCE -
DESIGNED FOR U.S. ARCHITECTURAL PREFERENCES

- Best-in-class NFRC U-Factors as low as 0.16 BTU/hr.sqft.°F (fixed) and 0.20 BTU/hr.sqft.°F (operable)
- AAMA AW-100 Architectural Performance Class
- 3-11/16" frame depth with 44mm polyamide thermal barrier and foam cavity fillers
- Incorporates engineered polymers and aluminum extrusions where their inherent material properties are best suited
- Narrow sightlines and flush, convection-baffled, operable vents
- Fixed; in- or out-swing casement; top-hinged, hopper or awning vents (detail)
- 1" exterior glass offset complements curtainwall and storefront systems
- Heavy butt hinges or concealed, stainless steel, four-bar friction hinges carry triple glazing with ease

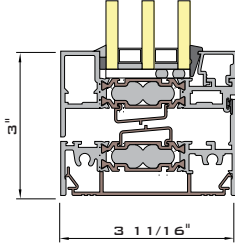

2250i-XP
INVENT.PLUS



in.vent.plus™

Allowable Air	Water	NFRC U-Factor	CRF _f	STC OITC
0.10 cfm/sqft at 6.24 psf	15 psf	0.16 to 0.51 BTU/hr.sqft.°F	46 to 65	34 to 41 28 to 35

Performance can vary with glass and hardware package selected.
Minimum vent sizes apply for certain hardware packages.

INVENT -HP -XLT

HURRICANE IMPACT RESISTANT
FIXED AND OPERABLE WINDOWS

- 3-7/8" and 4-7/8" frame depth
- 24mm XLT polyamide thermal barrier
- AAMA AW-100 Architectural Performance Class
- Fixed, project-out awning, project-in or project-out casement
- Integral blinds with access doors available
- Multi-lock hardware option
- Large "D" missile impact tested to ASTM E 1996 and TAS protocols for Wind Zones 1-4 - Miami-Dade NOAs
- "E" missile impact tested for essential facilities to ASTM E 1996 and TAS protocols for Wind Zones 3-4 - Miami-Dade NOAs

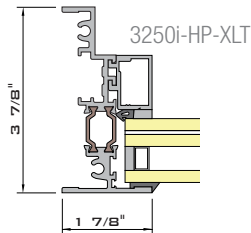

Allowable Air	Water	NFRC U-Factor	CRF _f	STC OITC
0.10 cfm/sqft at 6.24 psf	15 psf	0.34 to 0.64 BTU/hr.sqft.°F	46 to 65	31 to 42 26 to 37

Test results may vary



INVENT RETRO™ -XLT

BEVELED, OGEE OR COVE GLAZING REBATES TO REPLICATE HISTORICAL PUTTY-GLAZED WINDOWS

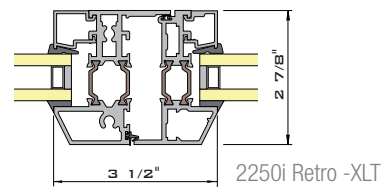

- 2-7/8", 3-7/8" and 4-7/8" frame depth
- 18mm and 24mm XLT polyamide thermal barriers
- AAMA AW-100 Architectural Performance Class
- Optional equal sightlines at vents and fixed lites
- Triple glazing and integral blinds available
- Grid muntins or true divided lite (pictured)
- Optional decorative cove glazing beads (pictured)
- Optional multi-lock hardware for improved accessibility
- Innovative, French casement available (pictured) for Juliet balconies, terraces, or ground floor use

Allowable Air	Water	NFRC U-Factor	CRF _f	STC _{OITC}
0.10 cfm/sqft at 6.24 psf	15 psf	0.39 to 0.64 BTU/hr.sqft.°F (est.)	46 to 60 (est.)	31 to 42 26 to 37

Test results may vary



INVENT SIMULATED DOUBLE HUNG

OFFSET GLASS PLANES TO REPLICATE DOUBLE-HUNG SASH, BUT EASY TO OPERATE, DURABLE, AND WEATHER-TIGHT

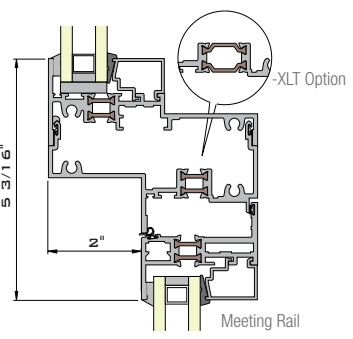

- 3-1/2" or 4-1/2" frame depth with polyamide thermal barrier
- AAMA AW-100 Architectural Performance Class
- Fixed, hopper, awning, or casement
- Integral blinds with access doors available
- Architecturally-flat 6mm glass - No balances
- XLT option with glazed-in muntin grid for historical renovation (pictured)

Type	Allowable Air	Water Resistance	NFRC U-Factor BTU/hr.sqft.°F (est)	CRF _f (est)	STC _{OITC}
4250i or -XLT Fixed Upper	0.10 cfm/sqft at 6.24 psf	15 psf	0.23 to 0.58	56 to 71	31 to 42 26 to 37
4250i or -XLT Vent Lower			0.35 to 0.60	46 to 61	

Test results may vary



WINDOW REPLACEMENT PANNING AND MUNTIN GRIDS

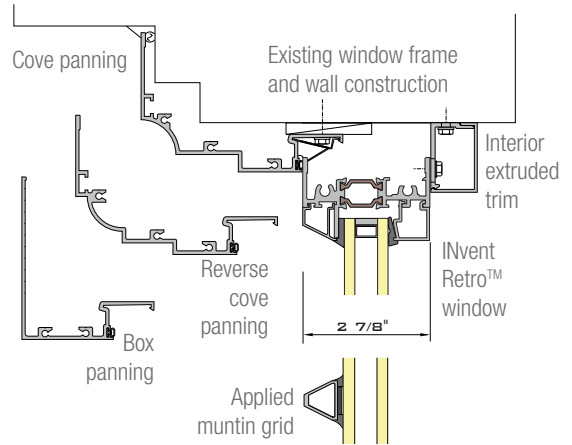

Removal of existing operable sash only, leaving frames in place, speeds installation and minimizes disruption. Extruded aluminum "panning" prepares the opening.

Muntins are available as true divided lites, snap-in grids, glazed-in grids, silicone-applied or between-glass muntins.

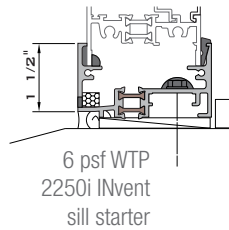

EASE OF INSTALLATION RECEPTORS AND ANCHORS

All INvent Series products are available with the same consistent family of accessories, to minimize installation time, and help ensure field quality control.

www.wausauwindow.com . Download details, specifications, and product performance information - and -
www.nfrc.org . For a comprehensive list of Wausau's NFRC-certified thermal performance data



WINDOW HARDWARE FOR OCCUPANT OR CUSTODIAL OPERATION - "ADA" ACCESSIBILITY OPTIONS



BETWEEN-GLASS BLINDS LOW MAINTENANCE AND GLARE CONTROL

- Available with 1" or 5/8" aluminum slats in 16 standard colors
- Occupant privacy and glare tilt control with slip-clutch feature
- Concealed raise-lower cords for uniform exterior appearance
- Hinged interior doors for custodial access
- Dual- or triple-glazed options for control of solar heat gain

Leaving existing windows in place? Check out Wausau's S.E.A.L. interior accessory windows for sound, energy, air and light control

INVENT -BHM

**SHOCK-TUBE TESTED
BLAST HAZARD MITIGATION**

- 2-1/2", 3-1/2" and 4-1/2" frame depth with polyamide thermal barrier - Two color option
- Fixed, awning, or project-out casement - XLT option, triple glazing, project-in hopper and casement available for some applications
- Various 2250i and 3250i-BHM configurations achieve ASTM F 1642 "Minimal Hazard" or "No Hazard" rating, tested at 6 psi peak, 42 psi-msec impulse
- Various 4250i-BHM configurations achieve ISC Performance Conditions 1, 2, 3a or 3b, tested at 10 psi peak, 89 psi-msec impulse

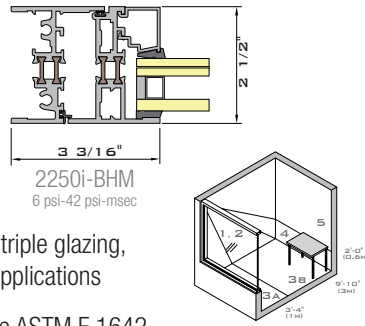

DoD - UFC Department of Defense Unified Facilities Criteria UFC 4-010-01 (October 2013)
"DoD Minimum Anti-Terrorism Standards for Buildings"

Level of Protection	Potential Glazing Hazards (Glazing hazard levels from ASTM F 1642)
Below AT Standards	Catastrophic failure. Lethal potential. "High" hazard rating.
Very Low	Glazing fractures, and is propelled into the building. Serious injury potential. "Low" hazard rating.
Low	Glazing fractures, may leave frame at reduced velocity. Does not present a significant injury hazard. "Very low" hazard rating.
Medium	Glazing fractures, glass dust and slivers. "Minimal" hazard rating.
High	Glazing does not break. "No hazard."

IMPORTANT NOTES: Stand-off distance requirements vary widely with building site, perimeter control and stand-off distance. Charge Weight 1 lb. It may control window design, depending on corresponding stand-off distances and glazing resistance. UFC Paragraph 1-11 "Design Submittals" requires determination of applicable explosive weights, level of protection, and stand-off distance(s). This is the responsibility of the AE or security/blast consultant; not the window/curtainwall manufacturer or installer.

GSA-ISC General Services Administration Inter-Agency Security Committee
"Security Design Criteria for New Federal Office Buildings or Major Modernizations"

Performance Condition	Protection Level	Hazard Level	Description of Window Glazing Response
1	Safe	None	No glazing breakage or visible damage.
2	Very High	None	Glazing cracks-Dusting of fragments.
3a	High	Very Low	Glazing cracks-Fragments on floor within 3'-4" (1m) of window.
3b	High	Low	Glazing cracks-Fragments on floor within 10'-9" (3m) of window.
4	Medium	Medium	Glazing cracks-Fragments impact lower 2'-0" (0.6m) of wall.
5	Low	High	System fails catastrophically.

IMPORTANT NOTE: Determination of peak pressure, impulse, and Performance Condition (to include Hazard Condition and Protection Level) is the responsibility of the Owner's security/blast consultant; not the window/curtainwall manufacturer or installer. Design parameters typically range from 4 psi peak and 28 psi-msec impulse, to 10 psi peak and 89 psi-msec impulse.

ADA ACCESSIBILITY FOR WINDOWS

Wausau's accessible projected windows are **laboratory-proven capable** of operating with one hand using a force of five pounds or less, to unlock, open, close, and lock, without tight grasping, pinching or twisting of the wrist.

- All INvent™ Series and the 4250-Z Zero Sightline Series
- Project-out awning, in-swing or out-swing casement
- AAMA Architectural AW-100 Performance Class
- No reductions in air, water or structural performance for laboratory testing of accessible vents

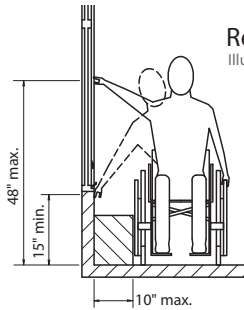

Reach Diagram
Illustrative Example Only



Operating Force Test
Roto-operator force-to-open



Wisconsin Veterans' Home Skilled Nursing Facility Chippewa Falls, Wisconsin
Photo: Phil Weston Weston Imaging Group, Inc.

INvent Series windows may be finished in a color palette of over 30,000 choices, including exciting new **copper anodize**.

Liquid or powder paint coatings are applied using VOC-free processes.

The frosty, matte finish of eco-friendly anodize is ideal for Wausau's high recycled content aluminum framing.

"INvent, INvent Retro and INvent.PLUS" are trademarks of Apogee Wausau Group, Inc. All rights reserved.
© 2014 Apogee Wausau Group, Inc.



WAUSAU

WINDOW AND WALL
SYSTEMS

7800 INTERNATIONAL DRIVE WAUSAU, WI 54401
TOLL FREE 1 877 678 2983 FAX 1 715 843 4350
E-MAIL INFO@WAUSAUWINDOW.COM

