

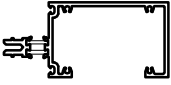

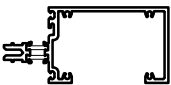

Series Components: 4" Back Member, 3/4" cover & 1 7/8" glazing pocket

Captured Glazing Frame Members

DESCRIPTION	Part NO. Length	lbs/pc.	Price/pc.
 PERIMETER-OPEN BACK HORIZONTAL/VERTICAL	994685 24'-2"	52.4	\$.00
 PERIMETER-OPEN BACK w/SETTING CHAIR 967817	995982 22'-0"	49.1	\$.00
 INTERMEDIATE TUBE HORIZONTAL/VERTICAL	995940 24'-2"	61.2	\$.00
 INTERMEDIATE TUBE w/SETTING CHAIR 967817	995752 22'-0"	57.1	\$.00
 VERTICAL MULLION-FEMALE STACK w/MALE 862971	994687 24'-2"	39.3	\$.00
 VERTICAL MULLION-MALE STACK w/FEMALE 994687 USE W'STP 9680	862971 24'-2"	35.3	\$.00

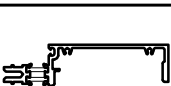

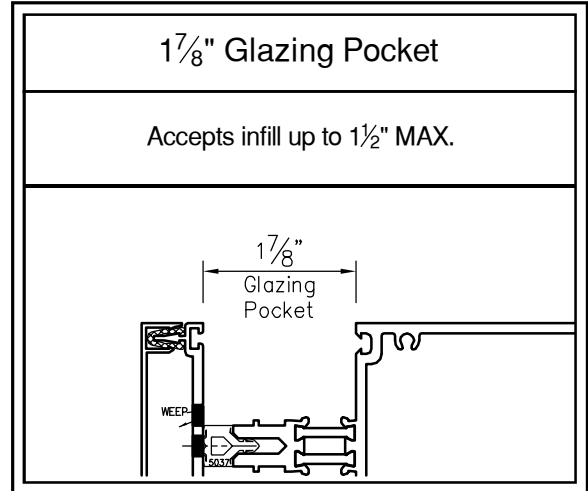

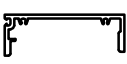
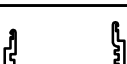
Structural Glazing Frame Members

 VERTICAL MULLION-FEMALE STACK w/MALE 862971	967054 (MOD) 24'-2"	29.7	\$.00
 VERTICAL MULLION-MALE STACK w/FEMALE 967054 USE W'STP 9680	862971 24'-2"	35.3	\$.00

NOTES:
Additional Lengths are available.
Contact a Wausau Representative for Sizing and Pricing.

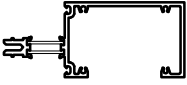
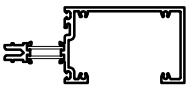
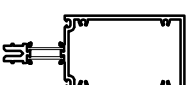
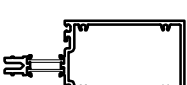
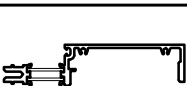

Series Components: 4" Back Member, 3/4" cover & 2 3/8" glazing pocket

Captured Glazing Frame Members

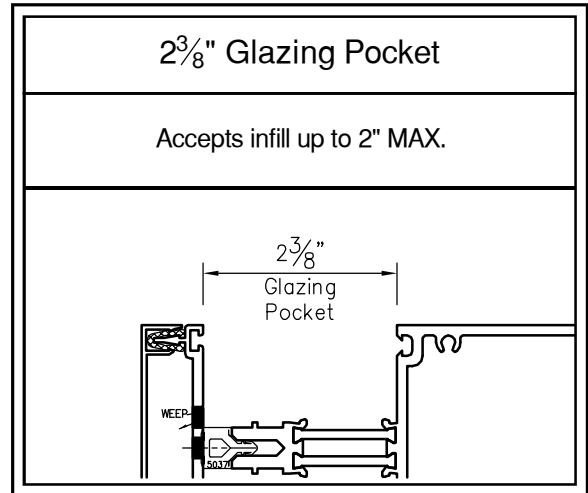
DESCRIPTION	Part NO. Length	lbs/pc.	Price/pc.
 PERIMETER-OPEN BACK HORIZONTAL/VERTICAL	994933 22'-0"	47.6	\$.00
 PERIMETER-OPEN BACK w/SETTING CHAIR 967817	994977 24'-2"	54.0	\$.00
 INTERMEDIATE TUBE HORIZONTAL/VERTICAL	994931 22'-0"	55.9	\$.00
 INTERMEDIATE TUBE w/SETTING CHAIR 967817	994979 24'-2"	62.7	\$.00
 VERTICAL MULLION-FEMALE STACK w/MALE 862971	994930 24'-2"	39.3	\$.00
 VERTICAL MULLION-MALE STACK w/FEMALE 994930 USE W'STP 9680	862971 24'-2"	35.3	\$.00



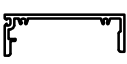







Structural Glazing Frame Members









 VERTICAL MULLION-FEMALE STACK w/MALE 862971	967054 (MOD) 24'-2"	29.7	\$.00
 VERTICAL MULLION-MALE STACK w/FEMALE 967054 USE W'STP 9680	862971 24'-2"	35.3	\$.00

NOTES:
Additional Lengths are available.
Contact a Wausau Representative for Sizing and Pricing.



@ 1 7/8" Glazing Pocket (1 1/2" Infill MAX)

EXTERIOR GASKET		INFILL WIDTH	INTERIOR GASKET	
		1/4" INFILL		
1/4" GAP-EPDM			3/8" GAP-EPDM	
6018 1000'	\$.00	Use Glazing Insert 907474 & Adapter 418	5005 375'	\$.00
				
1/4" GAP-EPDM		Use Glazing Insert 906681 & Adapter 418	1/8" GAP-NEOPRENE	
6018 1000'	\$.00		5139 1500'	\$.00
		1 5/16" INFILL		
5/16" GAP-EPDM			1/4" GAP-EPDM	
5003 500'	\$.00	No Glazing Insert Req'd	5141 500'	\$.00
				
1/4" GAP-EPDM		No Glazing Insert Req'd	1/8" GAP-NEOPRENE	
6018 1000'	\$.00		5139 1500'	\$.00

@ 2 3/8" Glazing Pocket (2" Infill MAX)

EXTERIOR GASKET		INFILL WIDTH	INTERIOR GASKET	
		1/4" INFILL		
1/4" GAP-EPDM			1/8" GAP-NEOPRENE	
6018 1000'	\$.00	Use Glazing Insert 967815 & Adapter 418	5139 1500'	\$.00
				
1/4" GAP-EPDM		Use Glazing Insert 907474 & Adapter 418	1/8" GAP-NEOPRENE	
6018 1000'	\$.00		5139 1500'	\$.00
		1 3/4" INFILL		
1/4" GAP-EPDM			3/8" GAP-EPDM	
6018 1000'	\$.00	No Glazing Insert Req'd	5005 375'	\$.00
				
1/4" GAP-EPDM		No Glazing Insert Req'd	1/8" GAP-NEOPRENE	
6018 1000'	\$.00		5139 1500'	\$.00

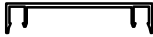

Standard Pressure Plates & Covers

DESCRIPTION	Part NO. Length	Price/pc.
 SNAP-ON COVER	963582 24'-2"	\$.00
Additional Cover Depths are available. Contact a Wausau Representative for Sizing and Pricing.		
 PRESSURE PLATE PRE-PUNCHED 4" o.c.	967056 24'-2"	\$.00
 PVC INSULATOR DART USE at PRESSURE PLATE 1" LONG, SPACED 12" O.C.	8739 8,000 pcs	\$.00

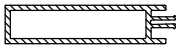
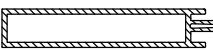
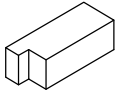
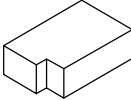
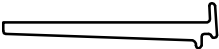

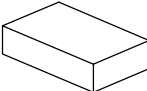

Glazing Components

 EPDM THERMAL SEPARATOR	5037 600'	\$.00
 1 7/8" PVC GLAZING SPACER	468 12'-0"	\$.00
 2 3/8" PVC GLAZING SPACER	438 10'-0"	\$.00
 NEOPRENE SPONGE ZONE DAM (NARROW)	1 7/8" Pocket 146184 2 3/8" Pocket 146122	\$.00
 NEOPRENE SPONGE ZONE DAM (WIDE)	1 7/8" Pocket 146172 2 3/8" Pocket 146134	\$.00
 ALUMINUM SETTING CHAIR	967817 17'-0"	\$.00



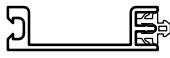

Structural Glazing Components

 GLAZING TAPE GT-922, 1/4" x 1/2"	142712 1000'	\$.00
 FOAM BAFFLE-20 ppi USE @ SSG Cover Weeps	134867 50 pcs	\$.00
 NEOPRENE SPONGE ZONE DAM	136906 50 pcs	\$.00

Glazing Inserts

DESCRIPTION	Part NO. Length	Price/pc.
 ALUMINUM GLAZING INSERT USE w/ADAPTER 418	967815 24'-2"	\$.00
 ALUMINUM GLAZING INSERT USE w/ADAPTER 418	907474 24'-2"	\$.00
 ALUMINUM GLAZING INSERT USE w/ADAPTER 418	906681 24'-2"	\$.00
 EPDM INSERT ADAPTER	418 750'	\$.00

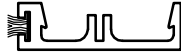
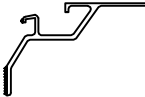
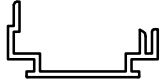
Miscellaneous Accessories

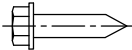
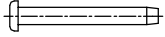
 DUAL DUROMETER W'STP USE at Male/Female STACK	9680 4,000'	\$.00
 WOOL PILE W'STP USE w/DOOR STOP 900443	5062	\$.00
 ALUMINUM DOOR STOP USE w/W'STP 5062	900443 20'-6"	\$.00
 PVC CAULK BACKER USE w/OPEN BACK PERIMETER FRAME	481 12'-0"	\$.00
 EXTRUDED ALUMINUM MULLION SPLICE	865674 11'-0"	\$.00
 FORMED ALUMINUM HAT CHANNEL 3" LONG	191457	\$.00
 PRESSURE PLATE FASTENER #14x1.0,HWH,SS,SMS	51602 100 pcs	\$.00
 ASSEMBLY FASTENER #10-14x1.5,TORX, PAN HD,SS,SMS	54305 100 pcs	\$.00