

Architectural Windows

2250 Series Insert Vents

Elevations Viewed From The Exterior

Section Contents

	Page(s)
Details - Glazed In Frame	Z2-2
Details - Flat Back Frame	Z2-3
Glazing Options	Z2-4
Blind Options	Z2-5 and Z2-6

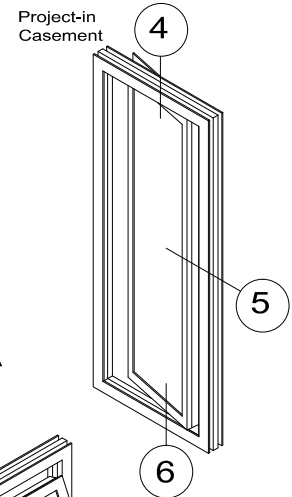
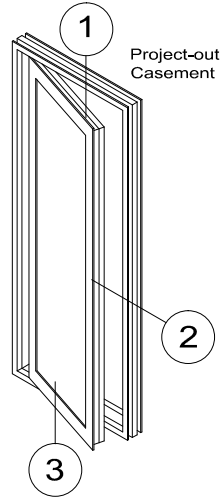

AAMA

AAMA Test Configurations (shown)

Architectural AW Class

For air, water, cycling and structural

Gateway Sizes

60" x 36"	Projected	1524 mm	x	914 mm
36" x 60"	Casement	914 mm	x	1524 mm

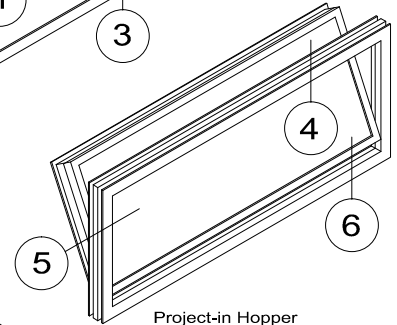
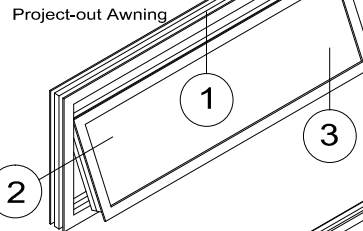

NFRC 100 Thermal Test Configurations (shown)

For U-Factor, SHGC and CR

Casement Frame Size	59" x 24"	1500 mm	x	600 mm
	24" x 59"	600 mm	x	1500 mm

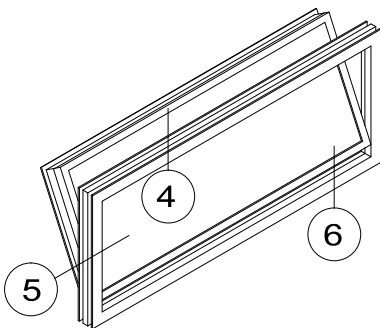

NFRC

Project-out Casement

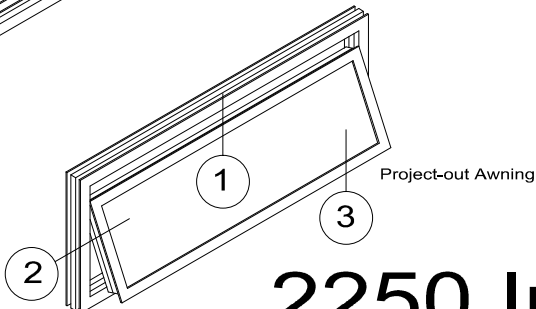
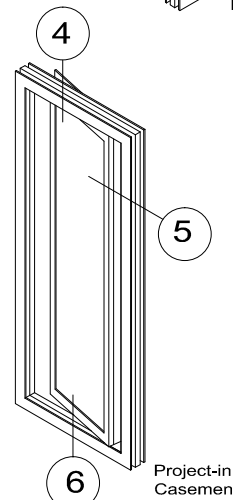
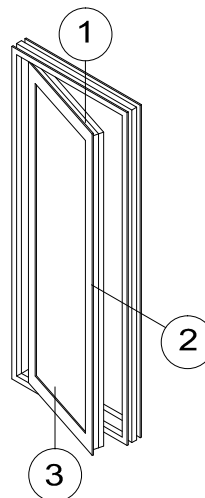

2250 Insert Vents

Contact A Wausau Representative For Other Possible Configurations.

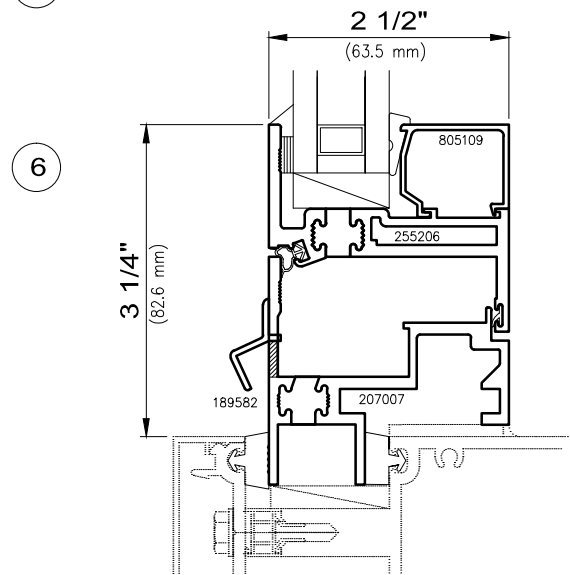
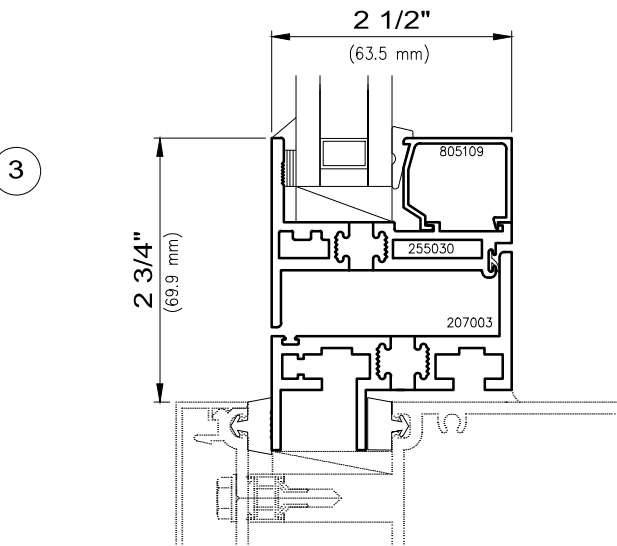
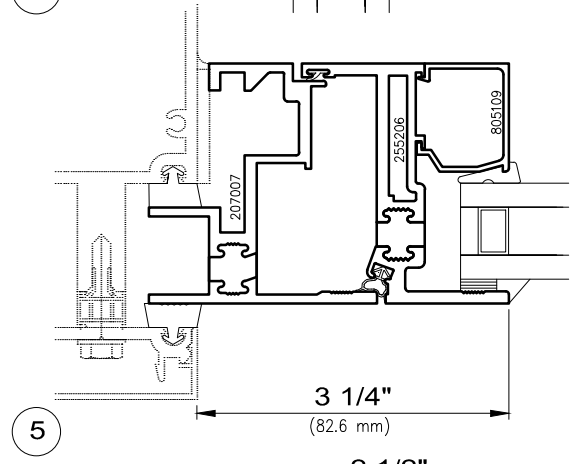
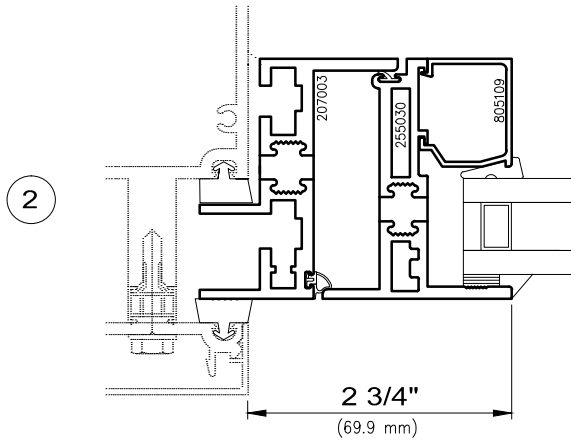
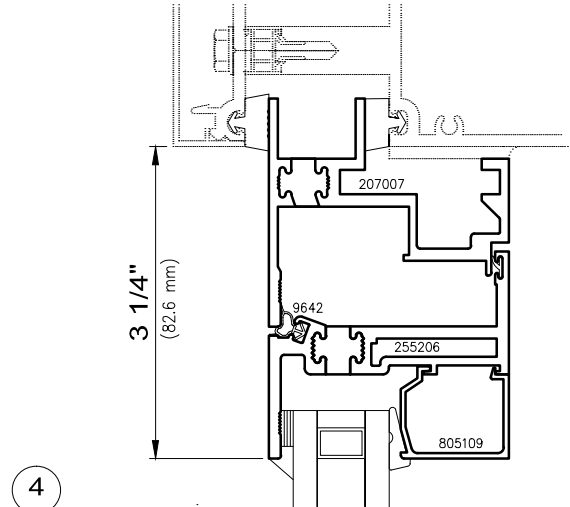
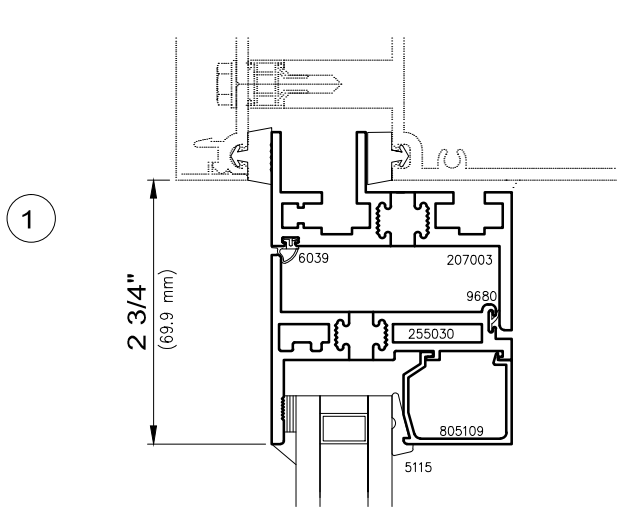



WAUSAU

WINDOW AND WALL
SYSTEMS

Flat Back Frame Details

Architectural Windows

2250 Series Insert Vents

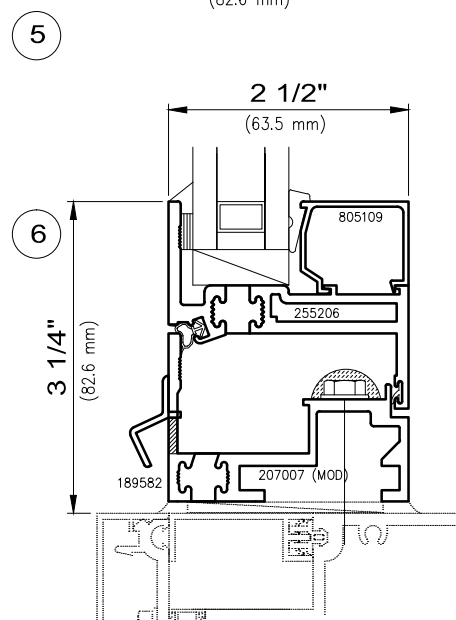
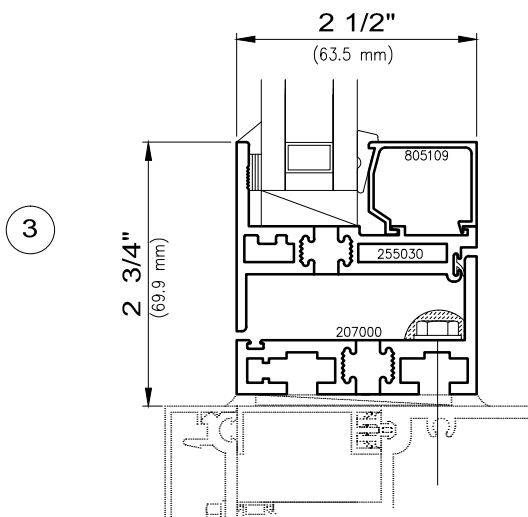
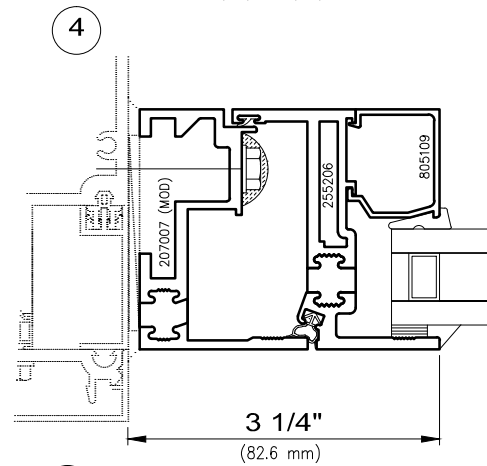
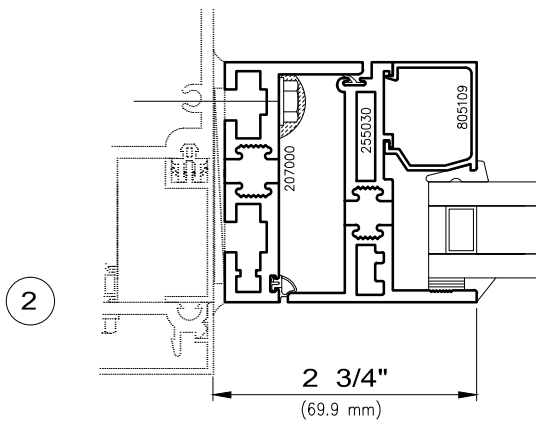
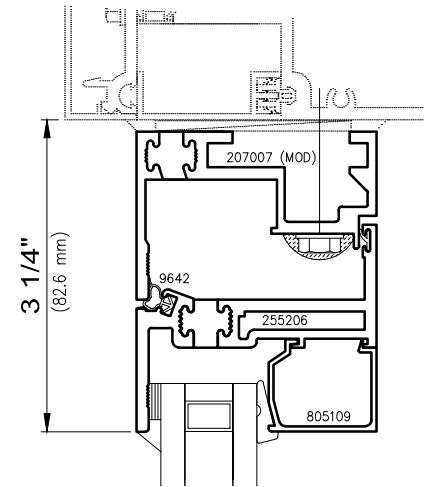
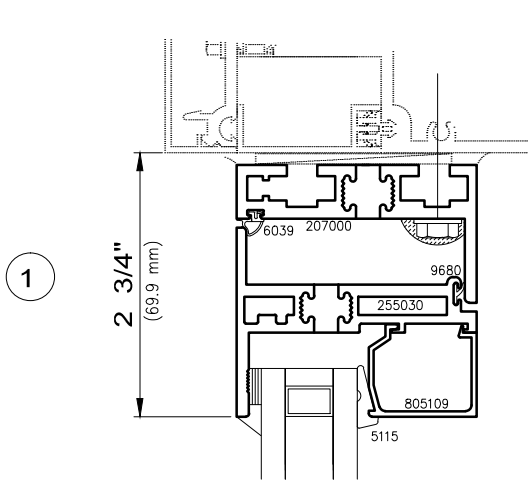

Non-stocked items shown - Minimum order quantity may apply

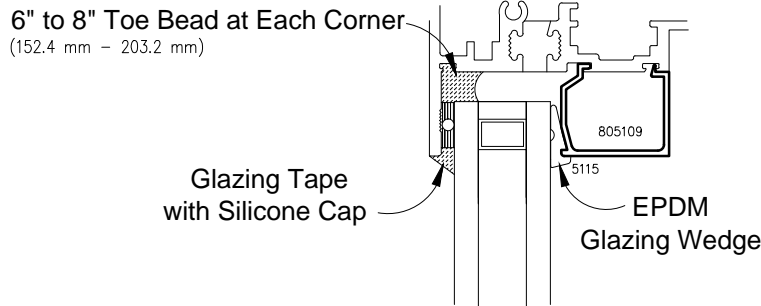

1" Insulating Glass
Inside Glazed

Optional Infill Thickness

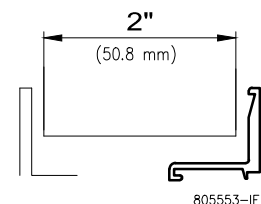
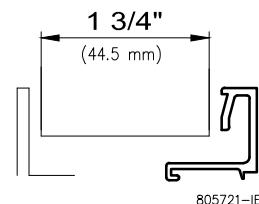
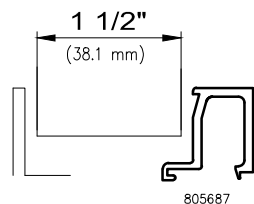
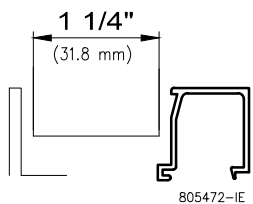
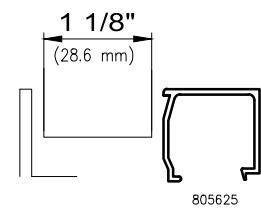
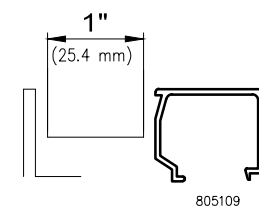
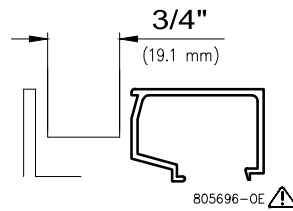
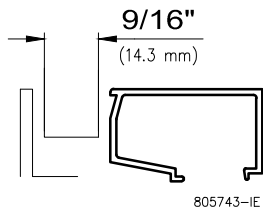
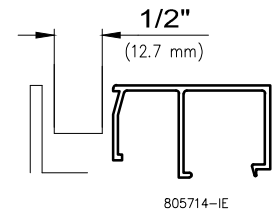
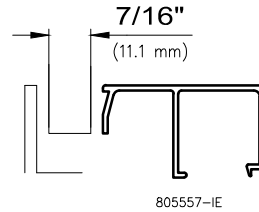
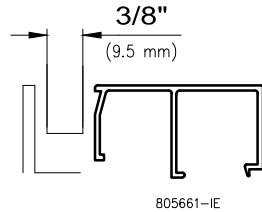
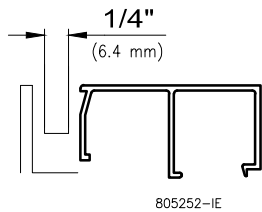

 - OBSOLETE TOOLING STATUS



Elevations Shown As Viewed From The Interior

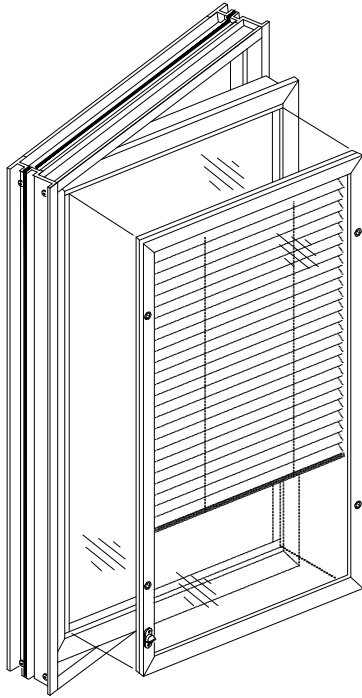

Lift-Out

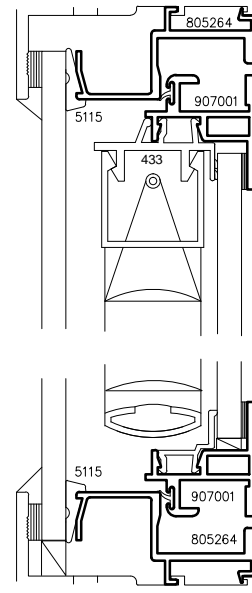
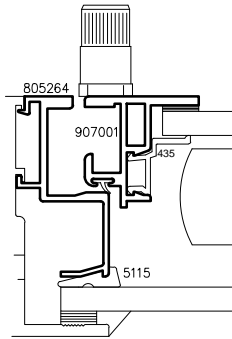

1" Blind/Dual Glazed

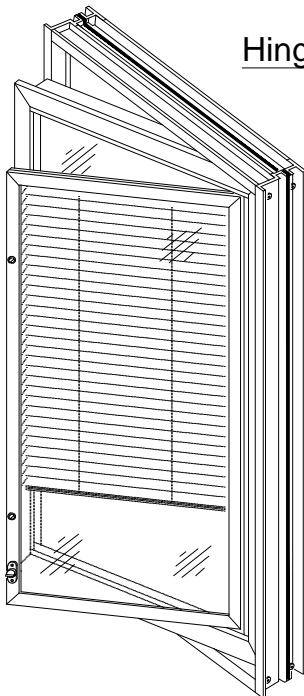

Hinged

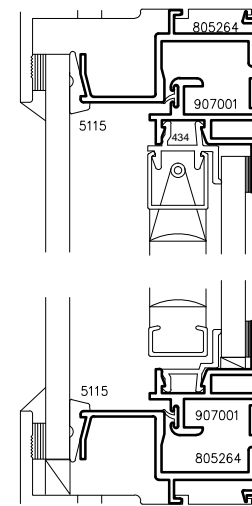
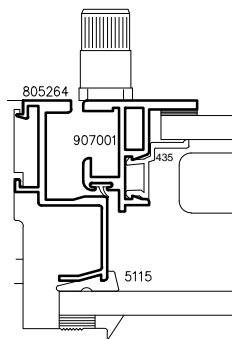

5/8" Blind/Dual Glazed

Elevations Shown As Viewed From The Interior

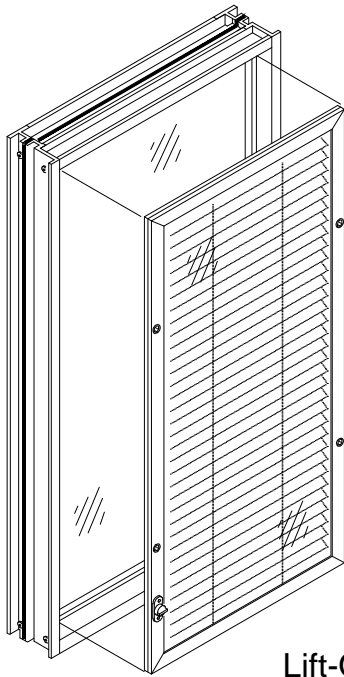

Lift-Out

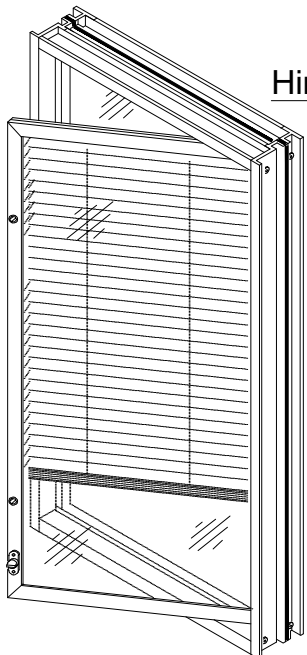

Hinged

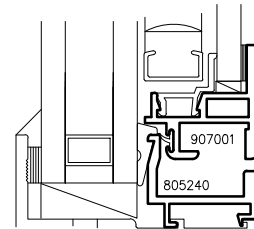
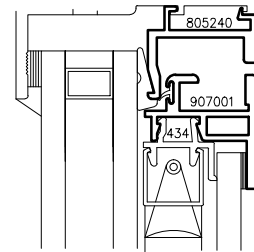
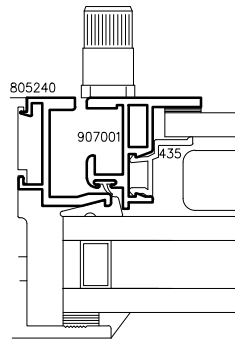

5/8" Blind/Triple Glazed