

Wausau Window and Wall Systems' SuperWall is a screw-spline pressure wall, offered in stock lengths for customer fabrication. 2-1/2" face width systems available in five different frame depths: 4750 Series (4-3/4" overall depth); 6250 Series (6-1/4" overall depth); 7250 Series (7-1/4" overall depth); 8250 Series (8-1/4" overall depth); 10250 Series (10-1/4" overall depth). Refer to guide specifications, test reports, system details, and fabrication/installation instructions for complete information. Systems of other width and depth are available. Contact a Wausau representative for more information.

Date:

Quote Due Date:

Project Name:

Project Location:

Material Ship Date:

Finish:

Company:

Contact Name:

Phone:

Fax:

Email:

Other Notes:

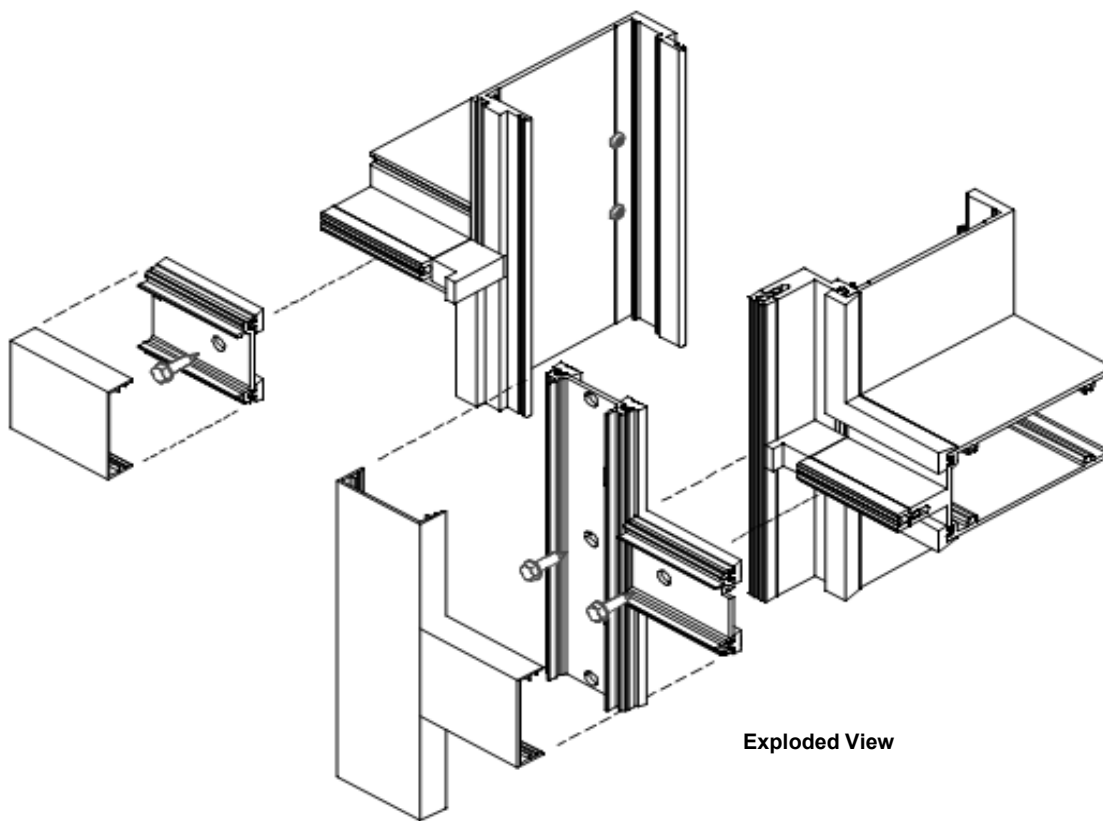

ADVANTAGE by WAUSAU

1" Infill Reference Detail

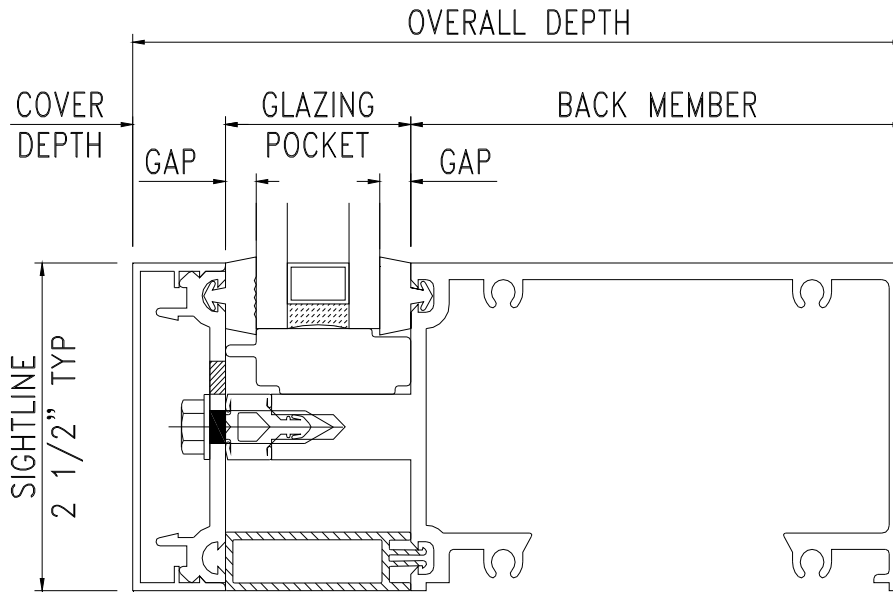

Reference Detail

Contents

Page

Superwall Reference Details	1 - 2
4750 SuperWall Framing	3
6250 SuperWall Framing	4
7250 SuperWall Framing	5
8250 SuperWall Framing	6
10250 SuperWall Framing	7
SuperWall Accessories - Glazing Materials, Standard Pressure Plates, Covers	8
SuperWall Accessories - Fasteners, Miscellaneous Accessories	9
SSG Carrier Frame Reference Detail	10
Superwall - Additional Glazing Accessories	11
Superwall - Formed Corner Anchors	12

Alternate Infill Reference Details

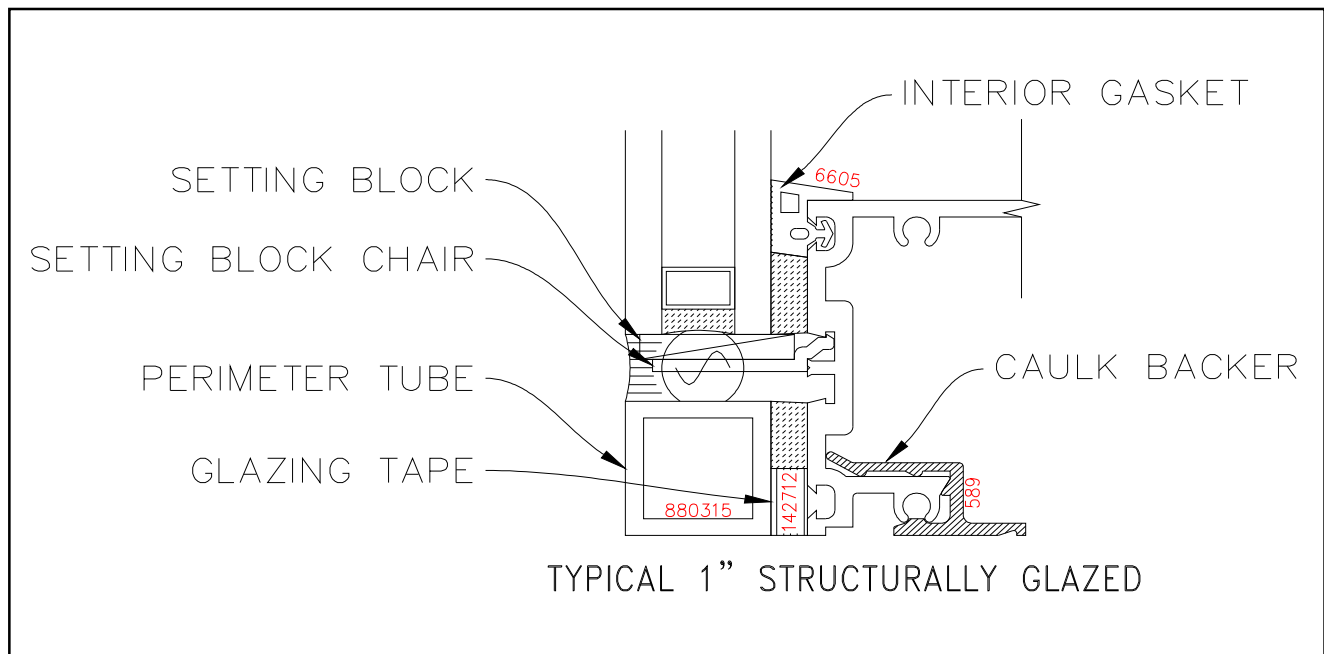

Note: Structural Glazing Make-up can include interior gasket 6605 or 5060.

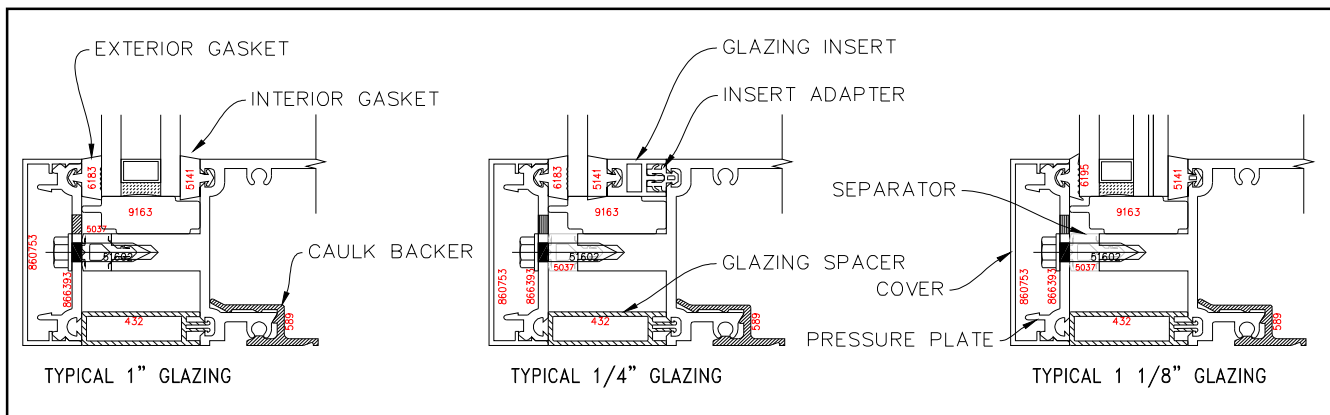



Non-Standard Glazing Available (1/4"~1 1/2" Infill), Contact a Wausau Representative for assistance with gaskets, zone dams, spacers, etc.

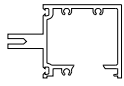
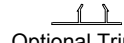
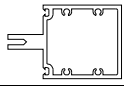

ADVANTAGE by WAUSAU

4750 Series Components: 2 1/2" back member, 3/4" cover, 1 1/2" glazing pocket
(Standard for: 1" infill with two 1/4" glazing gaskets)

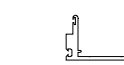
Captured Glazed Frames

PROFILE	PART NO. LENGTH	LBS/ PC	QTY
	T872345 24'-2"	48	_____
	T872354 24'-2"	6	_____
Optional Trim Cap			
NOTES Perimeter Open-Back Horizontal or Vertical Trim Cap is Required with F&T Anchors	F-Anchor T145027 : (10 per package)		_____
	T872344 24'-2"	53	_____
NOTES Intermediate Tube Horizontal or Vertical			
	T872349 24'-2"	40	_____
NOTES Vertical Mullion (Female) Use With Male T872348	T-Anchor T145028 : (10 per package)		_____
	T872348 24'-2"	30	_____
NOTES Vertical Mullion (Male) Use With Female T872349 Use Finstrip T9680			

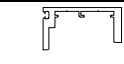
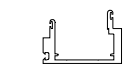
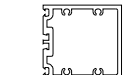
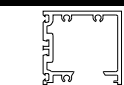
Structural Glazed Frames

	T872350 24'-2"	27	_____
NOTE Vertical Mullion (Female) Use With Male T872348			
	T872348 24'-2"	30	_____
NOTES Vertical Mullion (Male), Stack W/Female T872350 Use Finstrip T9680			
	T872346 24'-2"	43	_____
NOTE Intermediate Tube, Horizontal or Vertical			
	T872347 24'-2"	38	_____
	T872354 24'-2"	6	_____
Optional Trim Cap			
NOTES Perimeter Open-Back, Horizontal or Vertical Trim Cap is Required with F&T Anchors			

4750

Framing Accessories

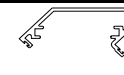
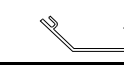

PROFILE	PART NO. LENGTH	LBS/ PC	QTY
	T872355 24'-2"	22	_____
NOTES Extruded Aluminum Hat Channel, Field Cut Lineals to 3" Long (typical) Use with Fastener 47210			Hat Channel can be used as splice.

Structural Glazed Corners

	T872352 24'-2"	33	_____
NOTES Vertical Mullion (Male) Use With Male T872351 Use Finstrip T9680			
	T872351 24'-2"	28	_____
NOTES Vertical Mullion (Female) Use With Female T872352			

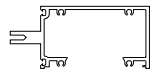
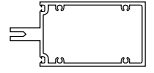
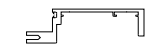

6250 Series Components: 4" back member, 3/4" cover & 1 1/2" glazing pocket
(Standard for: 1" infill with two 1/4" glazing gaskets)

Captured Glazed Frames

PROFILE	PART NO LENGTH	LBS/ PC.	QTY
	T872257 24'-2"	56	_____
Optional Trim Cap	T872269 24'-2"	9	_____
NOTES Perimeter Open-Back Horizontal or Vertical Trim Cap is Required with F&T Anchors	F-Anchor T145040 : (10 per package)		_____
	T872256 24'-2"	64	_____
NOTES Intermediate Tube Horizontal or Vertical	F-Anchor 145040 : (10 per package)		_____
	T872261 24'-2"	46	_____
NOTES Vertical Mullion (Female) Use With Male T872260	T-Anchor T145034 : (10 per package)		_____
	T872260 24'-2"	35	_____
NOTES Vertical Mullion (Male) Use With Female T872261 Use Finstrip T9680 (X2)	See female frame T872261 above for anchorage options.		_____

6250

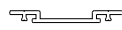
Framing Accessories

PROFILE	PART NO LENGTH	LBS/ PC.	QTY
	T872265 24'-2"	_____	_____
NOTES Extruded Mullion Splice, Field Cut lineals to Minimum 8" Long Can be used with all 6250 Frame Dies			
	T872266 11'-0"	_____	_____
NOTES Extruded Aluminum Hat Channel, Field Cut Lineals to 3" Long (typical) Use with Fastener T47210			

Structural Glazed Frames

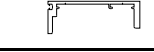
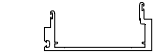
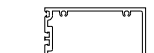
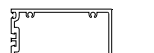
	T872262 24'-2"	32	_____
NOTES Vertical Mullion (Female) Use With Male T872260	T-Anchor T145034: (10 per package)		_____
	T872260 24'-2"	35	_____
NOTES Vertical Mullion (Male) Use With Female T872262 Use Finstrip T9680 (X2)	See female frame T872262 above for anchorage options.		_____
	T872258 24'-2"	54	_____
NOTES Intermediate Tube Horizontal or Vertical	F-Anchor See Note		_____
	T872259 24'-2"	46	_____
Optional Trim Cap	T872269 24'-2"	9	_____
NOTES Perimeter Open-Back Horizontal or Vertical Trim Cap is Required with F&T Anchors	F-Anchor See Note		_____



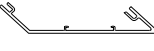

Structural Glazed Corners

	T872264 24'-2"	41	_____
NOTES 90° Vertical Corner (Male) Use With Female T872263 Use Finstrip T9680 (X2)	Formed Anchor T145053 & T145056 : (Pairs)		_____
	T872263 24'-2"	37	_____
NOTES Vertical Mullion (Female) Use With Male T872264	See male frame T872264 above for anchorage options.		_____

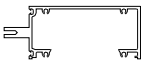

F-Anchor used in T872258 & T872259 are available.
Contact a Wausau representative for more information.

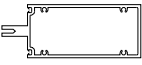
7250 Series Components: 5" back member, 3/4" cover & 1 1/2" glazing pocket
(Standard for: 1" infill with two 1/4" glazing gaskets)

Captured Glazed Frames

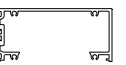
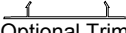

PROFILE	PART NO. LENGTH	LBS/ PC.	QTY
	T872274 24'-2"	60	_____
 Optional Trim Cap	T872284 24'-2"	13	_____
NOTES Perimeter Open-Back Horizontal or Vertical Trim Cap is Required with F&T Anchors	F-Anchor T145042 : (10 per package)		_____
	T872273 24'-2"	71	_____
NOTES Intermediate Tube Horizontal or Vertical	F-Anchor T145042 : (10 per package)		_____
	T872278 24'-2"	49	_____
NOTES Vertical Mullion (Female) Use With Male T872277	T-Anchor T145035 : (10 per package)		_____
	T872277 24'-2"	39	_____
NOTES Vertical Mullion (Male) Use With Female T872278 Use Finstrip T9680 (X2)	See female frame T872278 above for anchorage options.		_____

Structural Glazed Frames

	T872279 24'-2"	36	_____
NOTES Vertical Mullion (Female) Use With Male T872277	T-Anchor T145035 : (10 per package)		_____
	T872277 24'-2"	39	_____
NOTES Vertical Mullion (Male) Use With Female T872279 Use Finstrip T9680 (X2)	See female frame T872279 above for anchorage options.		_____
	T872275 24'-2"	61	_____
NOTES Intermediate Tube Horizontal or Vertical	F-Anchor See Note		_____
	T872276 24'-2"	49	_____
 Optional Trim Cap	T872284 24'-2"	13	_____
NOTES Perimeter Open-Back Horizontal or Vertical Trim Cap is Required with F&T Anchors	F-Anchor See Note		_____

7250

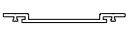
Framing Accessories

PROFILE	PART NO. LENGTH	LBS/ PC.	QTY
	T872282 24'-2"	_____	_____
NOTES Extruded Mullion Splice, Field Cut lineals to Minimum 8" Long Can be used with all 7250 Frame Dies			_____
	T872283 11'-0"	_____	_____
NOTES Extruded Aluminum Hat Channel, Field Cut Lineals to 3" Long (typical) Use with Fastener T47210			_____



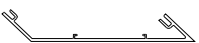

Structural Glazed Corners

	T872281 24'-2"	46	_____
NOTES 90° Vertical Corner (Male) Use With Female T872280 Use Finstrip T9680 (X2)	Formed Anchor T145054 & T145057 : (Pairs)		_____
	T872280 24'-2"	42	_____
NOTES Vertical Mullion (Female) Use With Male T872281	See male frame T872281 above for anchorage options.		_____



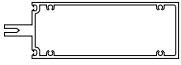

F-Anchor used in T872275 & T872276 are available.
Contact a Wausau representative for more information.

8250 Series Components: 6" back member, 3/4" cover & 1 1/2" glazing pocket
(Standard for: 1" infill with two 1/4" glazing gaskets)

Captured Glazed Frames

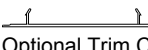

PROFILE	PART NO. LENGTH	LBS/ PC.	QTY
	T872286 24'-2"	63	_____
 Optional Trim Cap	T872296 24'-2"	17	_____
NOTES Perimeter Open-Back Horizontal or Vertical Trim Cap is Required with F&T Anchors	F-Anchor T145044: (10 per package)		_____
	T872285 24'-2"	78	_____
NOTES Intermediate Tube Horizontal or Vertical	F-Anchor T145044: (10 per package)		_____
	T872290 24'-2"	53	_____
NOTES Vertical Mullion (Female) Use With Male T872289	T-Anchor T145036: (10 per package)		_____
	T872289 24'-2"	43	_____
NOTES Vertical Mullion (Male) Use With T872290 Use Finstrip T9680 (X2)	See female frame T872290 above for anchorage options.		

Structural Glazed Frames



	T872291 24'-2"	39	_____
NOTES Vertical Mullion (Female) Use With Male T872289	T-Anchor T145036: (10 per package)		_____
	T872289 24'-2"	43	_____
NOTES Vertical Mullion (Male) Use With Female T872291 Use Finstrip T9680 (X2)	See female frame T872291 above for anchorage options.		
	T872287 24'-2"	68	_____
NOTES Intermediate Tube Horizontal or Vertical	F-Anchor See Note		_____
	T872288 24'-2"	53	_____
 Optional Trim Cap	T872296 24'-2"	17	_____
NOTES Perimeter Open-Back Horizontal or Vertical Trim Cap is Required with F&T Anchors	F-Anchor See Note		

8250

Framing Accessories

PROFILE	PART NO. LENGTH	LBS/ PC.	QTY
	T872294 24'-2"	_____	_____
NOTES Extruded Mullion Splice, Field Cut lineals to Minimum 8" Long Can be used with all 8250 Frame Dies			
	T872295 11'-0"	_____	_____
NOTES Extruded Aluminum Hat Channel, Field Cut Lineals to 3" Long (typical) Use with Fastener T47210			

Structural Glazed Corners

	T872293 24'-2"	52	_____
NOTES 90° Vertical Corner (Male) Use With Female T872292 Use Finstrip T9680 (X2)	Formed Anchor T145055 & T145058: (Pairs)		_____
	T872292 24'-2"	47	_____
NOTES Vertical Mullion (Female) Use With Male T872293	See male frame T872293 above for anchorage options.		

F-Anchor used in T872287 & T872288 are available.
Contact a Wausau representative for more information.

10250 Series Components: 8" back member, 3/4" cover & 1 1/2" glazing pocket
(Standard for: 1" infill with two 1/4" glazing gaskets)

Captured Glazed Frames

PROFILE	PART NO. LENGTH	LBS/ PC.	QTY
	T872298 24'-2"	71	_____
	T872308 24'-2"	22	_____
Optional Trim Cap			
NOTES Perimeter Open-Back Horizontal or Vertical Trim Cap is Required with F&T Anchors	F-Anchor T145046 : (10 per package)		_____
	T872297 24'-2"	92	_____
NOTES Intermediate Tube Horizontal or Vertical	T-Anchor NA F-Anchor T145046 : (10 per package)		_____
	T872302 24'-2"	60	_____
NOTES Vertical Mullion (Female) Use With Male T872301	T-Anchor T145038 : (10 per package)		_____
	T872301 24'-2"	50	_____
NOTES Vertical Mullion (Male) Use With Female T872302 Use Finstrip T9680 (X2)	See female frame T872302 above for anchorage options.		_____

Structural Glazed Frames

	T872303 24'-2"	47	_____
NOTES Vertical Mullion (Female) Use With Male T872301	T-Anchor T145038: (10 per package)		_____
	872301 24'-2"	50	_____
NOTES Vertical Mullion (Male) Use With Female T872303 Use Finstrip T9680 (X2)	See female frame T872303 above for anchorage options.		_____
	T872299 24'-2"	83	_____
NOTES Intermediate Tube Horizontal or Vertical	F-Anchor See Note		_____
	T872300 24'-2"	61	_____
	T872308 24'-2"	22	_____
Optional Trim Cap			
NOTES Perimeter Open-Back Horizontal or Vertical Trim Cap is Required with F&T Anchors	F-Anchor See Note		_____

F-Anchor used in T872299 & T872300 are available.
Contact a Wausau representative for more information.

10250

Framing Accessories

PROFILE	PART NO. LENGTH	LBS/ PC.	QTY
	T872306 24'-2"		_____
NOTES Extruded Mullion Splice, Field Cut lineals to Minimum 8" Long Can be used with all 10250 Frame Dies			
	T872307 11'-0"		_____
NOTES Extruded Hat Channel, Field Cut Lineals to 3" Long (typical) Use with Fastener T47210			



To achieve a 10 1/4" Corner Mullion,
8250 mullions must be used with an extender.

Structural Glazed Corners

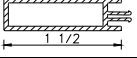

	T872293 24'-2"	52	_____
NOTES 90° Vertical Corner (Male) Use With Female T872292 Use Finstrip T9680 (X2)	Formed Anchor T145055 & T145058 : (Pairs)		_____
	T872292 24'-2"	47	_____
NOTES Vertical Mullion (Female) Use With Male T872293	See male frame T872293 above for anchorage options.		
	T872324 24'-2"	25	_____
NOTES Frame, Corner Extender Use with Fastener T50531	Needed X2 Per corner to Extend to 10 1/4" Depth		
	T50531 100 Per Package		_____
Corner Extender Fastener. Use with T872324 12 X .75, HWH, DRIL-FLEX			

2 1/2" SuperWall ACCESSORIES









Standard Glazing Pocket (1/4"-1" Infill)

PROFILE	PART NO. STD LENGTH	QTY REQUIRED
	T5037 500' Rolls	_____
EPDM Thermal Separator		
	T432 Packages of 30	_____
PVC Glazing Spacer Provided in 10'-0" lengths		
	T906148 24'-2" Lengths	_____
Aluminum Glazing Insert, For 1/4" Infill, Use W/ Adapter T418, Mill Finish		
	T418 750' Rolls	_____
EPDM Insert Adapter		

Standard Pressure Plates and Covers

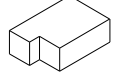
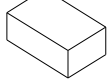



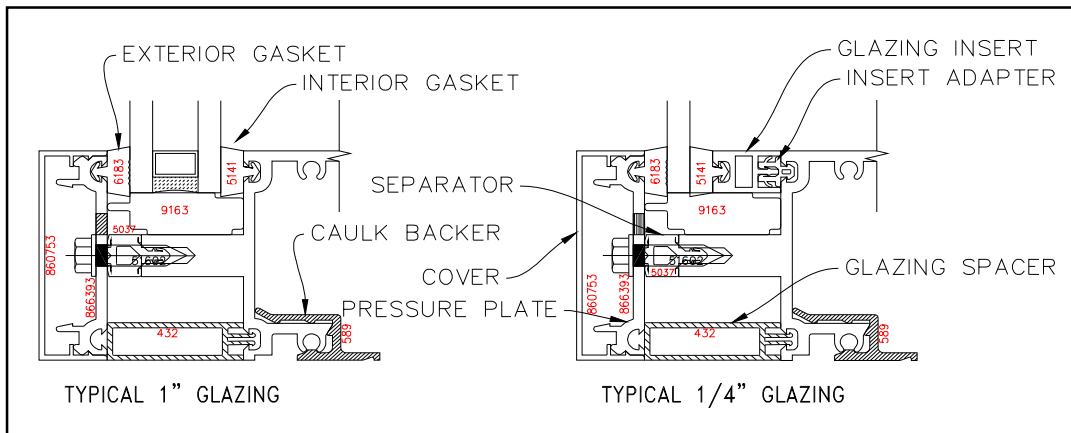

	T860753 24'-2" Lengths	_____
Snap-on Cover, 3/4" Deep.		
	T866393 24'-2" Lengths	_____
Pressure Plate, Pre-Punched 4" o.c.		

Standard Glazing Components

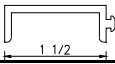
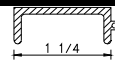
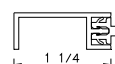

PROFILE	PART NO. STD LENGTH	QTY REQUIRED
	T5141 500' Rolls	_____
EPDM Glazing Gasket, Interior, 1/4" Gap		
	T6183 500' Rolls	_____
EPDM Glazing Gasket, Exterior, 1/4" Gap		
	T5060 500' Rolls	_____
Silicone Glazing Gasket, Interior, 1/4" Gap, Structural Glazing		
	T9163 Packages of 50	_____
Silicone Setting Block, 1/2" X 1 1/2" X 4" Long		
	T144463 Packages of 50	_____
Silicone Setting Block, 3/16" X 1 1/8" X 4" Long Used With Seeting Block Chair T872104, 6" Setting block Available, Contact Wausau for More Information.		
	T134685 Packages of 50	_____
Sponge Zone Dam		
	T136906 Packages of 50	_____
Sponge Zone Dam, Used With SSG		
	T137170 Packages of 50	_____
Sponge Zone Dam For 90° Corner		
	T142712 1000' Rolls	_____
GT-922 Glazing Tape, 1/4" X 1/2", Used With SSG		
	T134867 Packages of 50	_____
20-ppi Foam Baffle, Use at SSG Cover Weeps		







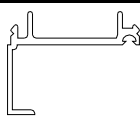

Standard Glazing Pocket (1/4" ~ 1" Infill)

PROFILE	PART NO. STD LENGTH	QTY REQUIRED
	904827 10'-0" Lengths	—
Aluminum Pocket Filler		
	9343 16'-0" Lengths	—
PVC Pocket Filler (Non-Vision Area), Use With Gasket 6183		
	906849 24'-2" Lengths	—
Aluminum Pocket Filler, Use With Adapter 418 & Gasket 6183		
	442 12'-0" Lengths	—
PVC Glazing Insert (Spandrel Area), For 1/4" Infill		
	906681 24'-2" Lengths	—
Aluminum Glazing Insert, For 1/2" Infill, Use With Adapter 418		
	883903 24'-2"	—
7/8" X 3/4" Tube, Adapter for 1/4" Structural Glazing Use With Fastener 510453		
	880315 22'-0"	—
1" X 1" Tube, For Perimeter Termination at 1" SSG, Use With Tape 142712		
	146419 Pieces	—
Temporary Glazing Clip, Use With Fastener 51602		

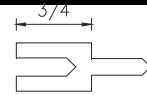
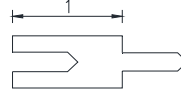

Standard Glazing Pocket (1/4" ~ 1" Infill)

PROFILE	PART NO. STD LENGTH	QTY REQUIRED
	872267 24'-2"	—
Pressure Plate for Extended covers, Pre-Punched 4" o.c. Use With Fastener 51602		
	866 24'-2"	—
Fiberglass Pressure Plate, Pre-Punched 4" o.c., Use With Fastener 51602		
	872166 24'-2"	—
Perimeter Pressure Plate W/ Return Leg, Pre-Punched 4" o.c. Use With Fastener 51602		
Non-Standard Glazing Available (1/4"~2" Infill), Contact a Wausau Representative for assistance with gaskets, zone dams, spacers, etc.		

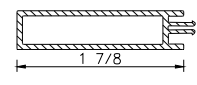
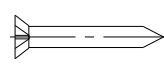
Glazing Components

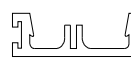

PROFILE	PART NO. STD LENGTH	QTY REQUIRED
	6610 Feet	—
EPDM Glazing Gasket, Interior, 1/4" Gap, Do not use with SSG With lip for reversed Open Back Framing (Detail on Page 7)		
	6605 Feet	—
Silicone Glazing Gasket, Interior, 1/4" Gap With lip for reversed Open Back Framing (Detail on Page 7)		
	6195 Feet	—
EPDM Glazing Gasket, Exterior, 1/8" Gap		
	5139 Feet	—
EPDM Glazing Gasket, Interior, 1/8" Gap		
	872477 24'-2" Lengths	—
Aluminum Stem Extender, Adds 3/4" to Typical Glazing Pocket		
	872331 24'-2" Lengths	—
EPDM Thermal Separator, Adds 1" to Typical Glazing Pocket		
	5052 Feet	—
EPDM Thermal Separator, Adds 1/4" to Typical Glazing Pocket		
	468 12'-0" Lengths	—
PVC Glazing Spacer Accommodates Glazing Pockets Up to 2 1/8"		
	510453 Pieces	—
Tube Adapter Fastener, 10 X 1.25, PH, FL., SS Use With Tube 883903		

Door Accessories

PROFILE	PART NO. STD LENGTH	QTY REQUIRED
	900443 20'-6"	—
Aluminum Door Stop, Use With W'Stp 5062		
	5062 Per Ft	—
Wool Pile W'Stp, Use With Door Stop 900443		



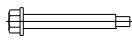

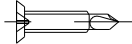

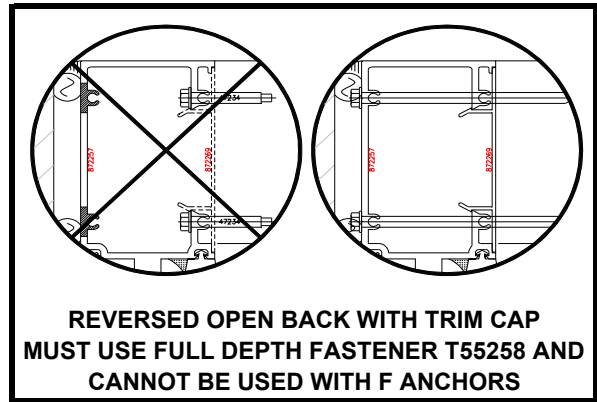
2 1/2" SuperWall ACCESSORIES



Assembly and Attachment Fasteners

PROFILE	PART NO. STD LENGTH	QTY
	T51602 Packages of 250	_____
Pressure Plate Fastener, #14x1.0,SMS,HWH,SS, 8" On Center at 1 1/2" Glazing Pocket (up to 1 1/4" Thick Infill)		
	T47234 Packages of 250	_____
Standard Assembly Fastener, #12 X 1.5,SMS,HWH,SS, 4 Per Connection		
	T55258 Packages of 100	_____
Assembly Fastener, #12 X 4.0,SMS,HWH,SS, 4 Per Connection Use with Reversed Open Back Frames Cannot be Used With F Anchors		
	T47210 Packages of 250	_____
Hat Channel Fastener, 14 X 1.0,PH,FL,HD,UC,2 Per Channel		



Miscellaneous Accessories

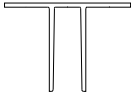





	T589 Packages of 30	_____
PVC Caulk Backer, Use With Open Back Perimeter Frame, Provided in 10' lengths.		
	T136217 Packages of 100	_____
Corner Washer, Used With Assembly Fastener T47234 at Corner Frames		
	T872268 11'-0" Lengths	_____
Anti-Buckle Clip, Field Cut Lineals to Minimum 6" Long		
	T872270 11'-0" Lengths	_____
Superwall Stem Cover, Field Cut to 1 3/8" Long		
	T9680 4,000' Rolls	_____
Dual Durometer Finstrip, Use at Male/Female Stacks		
	T872104 11'-0" Lengths	_____
Structural Glazing Setting Block Chair Field Cut to length, Match Setting Block Length (4" or 6" Typical)		

Framing Anchorage Accessories			
	6250 SERIES: T145034(M/F Stack)		6250 SERIES: T145040(TUBE&Open-Back) 145041(TUBE&Open-Back)
	7250 SERIES: T145035(M/F Stack)		7250 SERIES: T145042(TUBE&Open-Back) 145043(TUBE&Open-Back)
	8250 SERIES: T145036(M/F Stack)		8250 SERIES: T145044(TUBE&Open-Back) 145045(TUBE&Open-Back)
	10250 SERIES: T145038(M/F Stack)		10250 SERIES: T145046(TUBE&Open-Back) 145047(TUBE&Open-Back)
T Anchor, See Series offerings for more details and quantity call-outs. All T-Anchors in Mill Finish		F Anchor, See Series offerings for more details and quantity call outs. All F-Anchors in Mill Finish.	

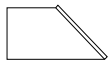
Corner Framing Anchorage Accessories

Provided in Powder Coated Finish

Provided Ship Direct From Manufacturer.

	T145053 Per Pc.		T145056 Per Pc.	Qty Per Pair (One Head, One Sill)	_____
Sill, Formed Steel Corner Anchor, 6250 Series		Head, Formed Steel Corner Anchor, 6250 Series			
	T145054 Per Pc.		T145057 Per Pc.	Qty Per Pair (One Head, One Sill)	_____
Sill, Formed Steel Corner Anchor, 7250 Series		Head, Formed Steel Corner Anchor, 7250 Series			
	T145055 Per Pc.		T145058 Per Pc.	Qty Per Pair (One Head, One Sill)	_____
Sill, Formed Steel Corner Anchor, 8250 Series & 10250 Series		Head, Formed Steel Corner Anchor, 8250 Series See series offerings for more details and quantity call outs			

See series offerings for more anchorage detail.

Wausau Window and Wall Systems' SuperWall SSG is a carrier frame system, offered in stock lengths for customer fabrication or factory fabricated and shipped knocked down for field assembly. Superwall SSG is a four-side silicone-glazed system. Availability includes all frame members and specified accessories in any standard anodize finish (including copper anodize) or any color paint.

Overall 2-1/2" face width systems available for any of five different typical superwall frame depths: 4750 Series (5-1/4" overall depth); 6250 Series (6-3/4" overall depth); 7250 Series (7-3/4" overall depth); 8250 Series (8-3/4" overall depth); 10250 Series (10-3/4" overall depth). Refer to guide specifications, test reports, system details, and fabrication/installation instructions for complete information. Systems of other width and depth are available. Contact a Wausau representative for more information.



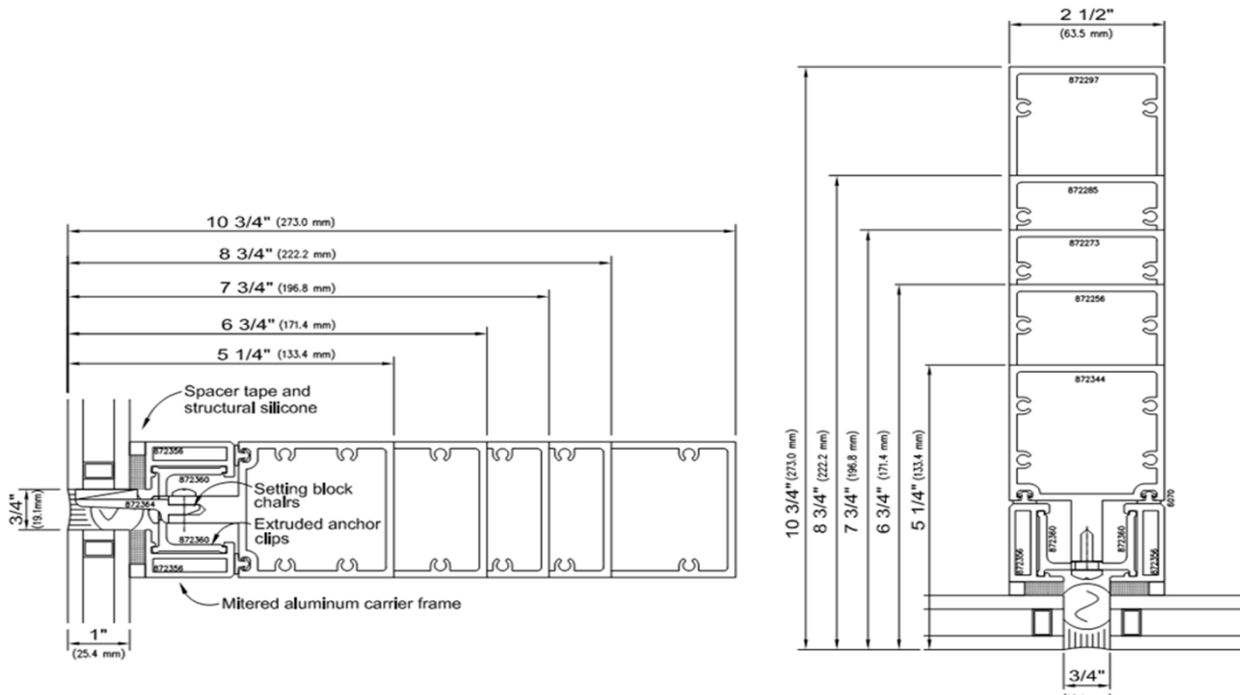







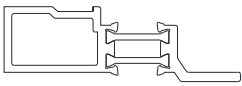

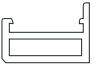
SSG Carrier Frame Reference



Superwall SSG has been tested to 60 psf at 4'-0" x 6'-0". Superwall SSG system has been designed for glazed units up to 7'-0" x 10'-0" (70 sq.ft.) at 40 psf maximum. Advantage by Wausau takes no responsibility for structural calculations.

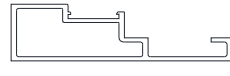

SSG CARRIER FRAME PIECES

PROFILE	PART NO LENGTH	LBS/ PC.	QTY	PROFILE	PART NO LENGTH	LBS/ PC.	QTY
	996039 22'-0"	15.6	_____		872357 22'-0"	18.6	_____
NOTES Perimeter Closure Used With Fastener 51420 at 18" O/C Inactive Extrusion			Status	NOTES Outside Corner Mullion Used With Anchor 145070			Status
			IE				IE
	872356 22'-0"	11.2	_____		145070 0'-6"	NA	_____
NOTES Typical Carrier Frame Use With Slide-in Retainer Clip 872360 or Snap-in Retainer Clip 872361			Status	NOTES Outside Corner Mullion Anchor - 6" Part Typically 18" on Center Used With Fastener 48317, 2 Per Anchor. Cut From Stocklength 872362-132 (IE)			Status
			IE				AM
	145068 0'-3"	NA	_____		872358 22'-0"	0.9	_____
NOTES Slide-In Retainer Clip - 3" Part Typically Applied 18" O/C Apply to Stem With Fastener 48942 Cut From Stocklength 872360-264 (IE)			Status	NOTES Inside Corner Mullion Used With Anchor 145071			Status
			IM				IE
	145069 0'-3"	NA	_____		145071 0'-6"	NA	_____
NOTES Snap-In Retainer Clip - 3" Part Typically Applied 18" O/C Apply to Stem With Fastener 48942 Cut From Stocklength 872361-264 (IE)			Status	NOTES Inside Corner Mullion Anchor - 6" Part Typically 18" on Center Used With Fastener 48317, 2 Per Anchor. Cut From Stocklength 872363-132 (IE)			Status
			IM				AM
	907759 22'-0"	41.1	_____		145003 0'-4"	NA	_____
NOTES Door Adapter Use With Slide-in Retainer Clip 872360 or Snap-in Retainer Clip 872361			Status	NOTES 4" Setting Chair for 1" Glass Cut From Stocklength 872364-132 (IE) Use With Fastener 51420 and Setting Block 134099			Status
			AE				IM
	CORNER KEY	NA	_____		145004 0'-4"	NA	_____
NOTES 188747 (IM) - Crimping Assembly (.236") 188749 (IM) - Fastener Assembly (.236"). Use with Fastener 20883 and with washer 21135, (4) each per corner 872359-264 (IE) - Available in Stock Length			_____	NOTES 4" Setting Chair For 1 3/4" Glass Cut From Stocklength 872365-132(IE) Use With Fastener 51420 and Setting Block 133230			Status
			_____				IM



SSG CARRIER FRAME PIECES

PROFILE	PART NO LENGTH	LBS/ PC.	QTY
	143675 2000'	NA	_____
NOTES	SGT-922 Glazing Tape - .25" X .25" -Use Between Carrier Frame and Glass		Status AM
		6070 5000'	NA _____
NOTES	.060 Gasket - EPDM Use With Carrier Frames		Status IP
		134099 pcs	NA _____
NOTES	1/4" Thick Silicone Setting Block For 1" Glass.		Status AP
		133230 pcs	NA _____
NOTES	1/4" Thick Silicone Setting Block For 1 3/4" Glass.		Status AP
		59022 pcs	NA _____
NOTES	.094" X .375" Spring Pin - 18-8 SS -Use if Required by Structural Engineer. Additional sizes available, Contact your Wausau Sales Rep for More Information.		Status AP
		51420 pcs	NA _____
NOTES	#10 X .625,SMS,PH,PAN,HD,SS Use with Perimeter Closure 996039 and Stem Extender 872366, 18" On Center. Used With Setting Block Chairs, 1 Per Chair.		Status AP
		48942 pcs	NA _____
NOTES	#14 X .75, SMS, Square DR, PAN, HD, SS Use With Slide-in and Snap-on Retainer Clips. One Per Clip.		Status AP

PROFILE	PART NO LENGTH	LBS/ PC.	QTY
	860753 24'-2"	7.4	_____
NOTES	Standard Cover Use With Pressure Plate 866393		Status AE
		866393 24'-2"	11.7 _____
NOTES	Standard Pressure Plate Use With Fastener 51602 - 18" On Center Use With Thermal Separator Gasket and Stem Extender 872366.		Status AE
		872366 20'-6"	9.9 _____
NOTES	Stem Extender, 3" at 18" On Center Use With Fastener 51420		Status IE
		20883 pcs	NA _____
NOTES	1/4-20 X .375,MS,PH,TR,SS Use With Corner Key 188749, Four Per Corner (With 21135)		Status AP
		21135 pcs	NA _____
NOTES	.25,WASHER,FLAT,SS Use With Corner Key 188749, Four Per Corner (With 20883)		Status IE
		48317 pcs	NA _____
NOTES	#10 X .50, SMS, PH, FL, HD, SS Use With Anchors 145070 And 145071. One Per Anchor.		Status AP